

**LEARNING RESOURCE MATERIAL**

**ON**

**ADVANCED CONSTRUCTION TECHNIQUES AND EQUIPMENT**

**DEPARTMENT  
OF  
CIVIL ENGINEERING**



**S.K.D.A.V. GOVERNMENT POLYTECHNIC, ROURKELA**

**PREPARED BY**

**SOUMYAA SAHOO**

**LECTURER IN CIVIL ENGINEERING**

### **Th 3. ADVANCED CONSTRUCTION TECHNIQUES & EQUIPMENT**

**Name of the Course: Diploma in Civil Engineering  
Semester 6th**

**Name of topics**

1. Advanced construction materials
2. Prefabrication
3. Earthquake Resistant Construction
4. Retrofitting of Structures
5. Building Services
6. Construction and earth moving equipments
7. Soil reinforcing techniques

## CHAPTER 1

### Advanced construction materials

- **FIBERS and Plastics**
- **Artificial Timbers**
- **Miscellaneous materials**

#### **FIBERS**

FIBER is a reinforcing material. FIBERS are small pieces of reinforcing material possessing certain characteristics and properties. FIBERS are considered as a construction material to enhance the flexural and tensile strength and as a binder that could combine Portland cement in bonding with cement matrices. FIBERS increase the structural integrity of the concrete. FIBERS are usually used in concrete to control cracking due to plastic shrinkage and drying shrinkage. It produces greater impact and abrasion resistance. Use of micro FIBERS offers better impact resistance. FIBER reinforced concrete (FRC) is a new structural material which is gaining increasing importance.

Steel fiber, carbon fiber and glass fiber are the new and recent trends used in the construction work.

FIBERS find applications in civil engineering on a large scale by virtue of their inherent advantages. High strength FIBERS, favourable orientation, the volume of FIBERS, FIBER length and diameter of FIBER have been found independently to improve the strength of composites.

#### **HISTORY**

The concept of using FIBERS as reinforcement is not new. In ancient times horsehair was used in mortar and straw in mudbricks. In 1900s asbestos FIBERS were used in concrete. But asbestos was discouraged due to detection of health risk. In 1963 Romualdi and Botson published their classic paper on FRC. After that new material like steel, glass and synthetic FIBERS replaced asbestos in concrete. Research is still in progress on this technology. FRC is considered one of the greatest advancement in the construction engineering. Some examples or famous structures built by FRC system

- Roman colosseum was built in 80 AD, used horse-hair as secondary reinforcement .
- Tipu Sultan's palace at Srirangpattnam has been built with Sheep's wool .



Fig- Roman colosseum



Fig- Tipu Sultan's palace at Srirangpattnam

#### **PROPERTIES OF FRC**

Fiber impart the following properties when introduced with concrete:-

- i. Increases the tensile strength of the concrete
- ii. Reduces the air voids and water voids.
- iii. Increases the durability of the concrete
- iv. Reduces bleeding in fresh concrete
- v. Gives more flexural strength as compare to strength given by rebar.
- vi. Restricts the growth of cracks under loads.
- vii. Some fibers produce greater impact, abrasion in concrete.

#### **1. Steel fiber**

Steel fibers are most commonly used fibers. Steel fiber reinforced concrete is basically cheaper and easier to use a form of rebar reinforced concrete. Rebar reinforced concrete uses steel bars that are laid within the liquid cement, which requires a great deal of prep work but make for a much stronger concrete.

The diameter may vary from 0.25mm to 0.75mm. Use of steel fiber makes significant improvements in flexural, impact and fatigue strength of concrete. The steel fiber is likely to get rusted and lose some of its strength. But investigations have shown that the rusting of the fibers take place only at the surface. It has the very high tensile strength of 1700N/m<sup>2</sup>. Steel fibers are incorporated in the shotcrete to improve its crack resistance, ductility and energy absorption and impact resistance characteristics. This imparts the concrete with greater structural strength, reduces cracking and helps protect against extreme cold. Steel fiber is often used in conjunction with rebar or one of the other fiber types. These are used for overlays of roads, airfield pavements, bridge decks, thin shells and plates.



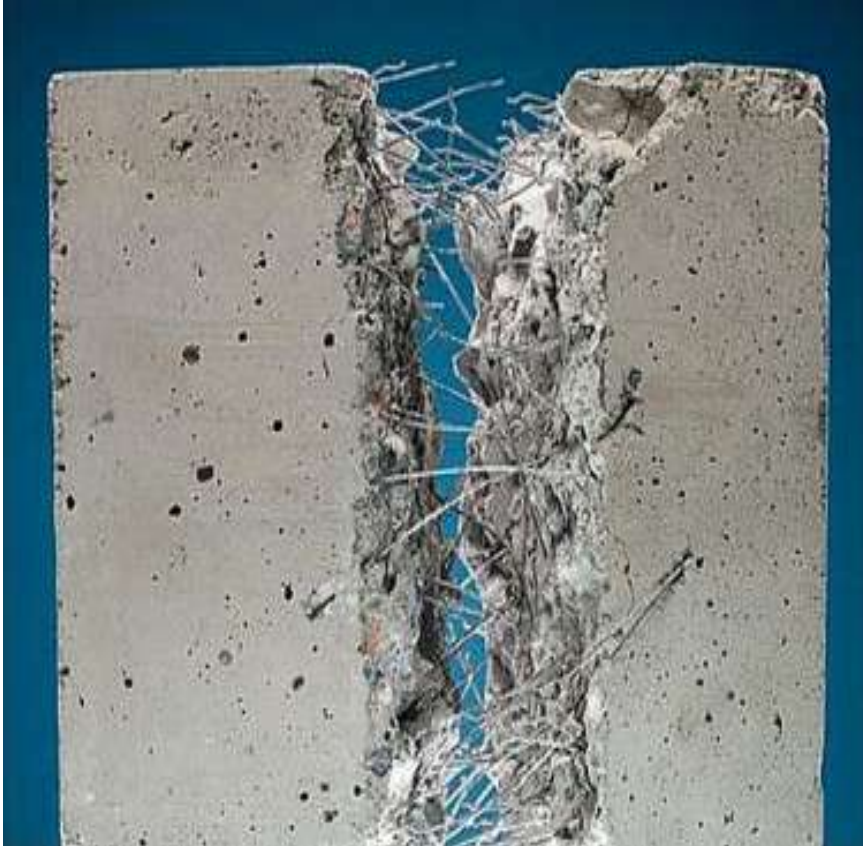

Fig- STEEL FIBERS

#### Properties of Steel Fibers

1. It increases the tensile strength of concrete.
2. It is more tough and hard.
3. It avoids corrosion and rust stains.
4. They are more elastic in nature.
5. Steel fibers are available with standards as ASTM 820/96, ASTM C 1116/95 and DIN 1045.
6. It has a tensile strength of 1.100 N/mm<sup>2</sup>.
7. They are available in the shapes like flat, hooked and undulated.

#### Applications of Steel Fibers on Field

1. Steel fibers are highly used in tunnel lining work.
2. It is mostly used in the construction of airport runways and highway pavements.
3. Most commonly used in precast concrete so as to increase the tensile strength.
4. They are used in shotcrete.
5. Used in the construction of parking.
6. It is used in anti-seismic buildings.

#### 2. Carbon fibers

Carbon fiber is a material consisting of extremely thin fibers about 0.005 mm to 0.010 mm in diameter and mostly composed of carbon atoms. Carbon fiber is alternately called graphite fiber. The carbon atoms are bonded together in microscopic crystals which are more or less aligned parallel to the long axis of the fiber. The crystal alignment makes size of fiber more strong. Number of carbon fibers are twisted together so as to form a Yarn which can be used as it exist or woven into a fabric. It can be combined with a plastic resin and wound or moulded to form composite materials like carbon fiber reinforced plastic to provide a high strength to weight ratio of the materials. The atomic structure of carbon fiber is similar to that of graphite consisting of sheets of carbon atoms arranged in a regular hexagonal pattern. Carbon fibers shows the number of properties very close to the properties of asbestos. Each carbon filament thread is a bundle of many thousand carbon filaments. A single such filament is a thin tube with a diameter of 5-8  $\mu\text{m}$  (i.e. 5-8 micrometers) and consists of almost exclusively of carbon.

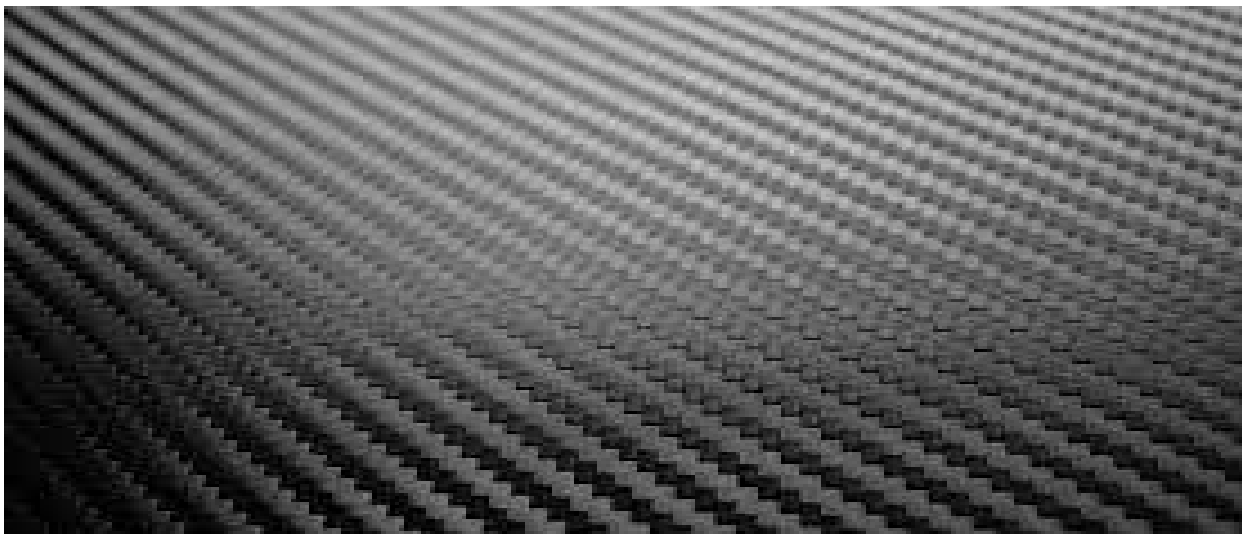

Fig-CARBON FIBER

#### Properties of Carbon Fibers

1. It has a high tensile strength, low weight and low thermal expansion.
2. They are rigid materials which are resistant to stretching and compression.
3. It is chemically inert or unreactive materials.
4. They are resistant to corrosion.
5. Fibers contained about 85% carbon has excellent flexural strength.

#### **Application of Carbon Fibers**

1. Carbon fiber is mostly used to reinforce composite material.
2. Reinforced Carbon-Carbon (RCC) consists of carbon fiber-reinforced graphite and is used structurally in high temperature applications.
3. It increases the tensile as well as compressive strength of concrete.
4. Due to high tensile strength, low weight and low thermal expansion it makes the carbon fiber very popular in aerospace, military and motorsports along with other competition sports.
5. Carbon fiber is extensively used in the bicycle industry, especially for high-performance racing bikes.
6. It is also used in some tennis rackets.
7. It is now being used in musical instruments for its weather resilience and ability to recreate the tone of guitars.

#### **3.Glass Fiber**

The glass fiber helps insulate the concrete in addition to making it stronger. Glass fiber also helps prevent the concrete from cracking over time due to mechanical or thermal stress. In addition, the glass fiber does not interfere with radio signals like the steel fiber reinforcement does. Glass fiber concretes are mainly used in exterior building façade panels and as architectural precast concrete. GFRC uses fine sand, cement, polymer, water, other admixtures and alkali-resistant glass fibers. Glass fiber reinforced cementitious composites have been developed mainly for the production of thin sheet components, with a paste or mortar matrix, and fiber content.



Fig-GLASS FIBER

#### **Properties of Glass Fibers**

1. It has high ratio of surface area to weight.
2. They have good thermal insulation.
3. It has a good tensile strength but has no strength against compression.
4. Compressive strength is weak but can be increased by reinforcing it with plastic.
5. When the glass fiber is reinforced with plastic, then reinforced material can resist both compressive and tensile forces as well.
6. It is resistant to chemical attack. However, if its surface area is increased, then it makes them more susceptible to chemical attack.
7. They are corrosion resistant.

#### **Application of Glass Fibers**

1. Corrugated fiber glass panels are widely used for outdoor canopy or greenhouse construction.
2. It is used as a reinforcing agent for many polymer products like FRP and GRP which uses tubs, pipes for drinking water and 'sewers, office plant containers and flat roof systems etc.
3. It is reinforced with plastic material so as to increase tensile strength.
4. Uses of regular fiber glass are mats, insulation, reinforcement sound absorption, heat resistance fabrics, corrosion resistant fabrics and high strength fabrics.
5. Glass fiber reinforced plastics are used in the house building market for the production of roofing laminate, door surrounds, over-door canopies, window canopies and dormers, chimneys, coping system, heads with keystone and sill etc.
6. The reinforced glass fiber with polymer and plastic is commonly used in fire water systems, cooling water systems, drinking water systems, sewage systems, waste water systems, gas system etc.

#### **PLASTIC**

In today's world, increasing problems related to plastics is a concern for every living species, so there is a need to find a solution to this problem. Hence, working on this issue, the main aim of this study is to tackle the plastic waste generated in abundance throughout the world. To gain success in this, a systematic method is employed which makes use of plastic extrude for reutilizing waste plastic into suitable construction materials.

#### **Polyvinyl Chloride (PVC)**

Cost effective to produce and highly resilient to chemical and biological damage, PVC is easy to work with and mould into shapes; making it an extremely practical material. In terms of properties, PVC is one of the most versatile. It can be used to create rigid, lightweight sheets, like Foamex, but it can also be used to make faux-leather materials like leatherette and pleather.

Common uses of PVC: Signage, furniture, clothing, medical containers, tubing, water and sewage pipes, flooring, cladding, vinyl records, cables, cleaning solution containers, water bottles.



### RPVC

Rigid Polyvinyl Chloride (RPVC) is a non-flammable material that is resistant to weathering. With the proper additives, RPVC can be UV stabilized so that it withstands sunlight.

Because PVC has an excellent resistance to aqueous solutions (like water), it is frequently used in applications that come in contact with water. Examples include doorways, windows, pipes (as in large diameter waste water pipes), and even extruded wire covering.

Home plumbing pipes are typically made out of RPVC, so this material is used very heavily in the construction and plumbing industries



## **Rigid Polyvinyl Chloride (RPVC) Pipe Manufacturing Industry.**

### **Production of RPVC Pipe**

[www.entrepreneurindia.co](http://www.entrepreneurindia.co)



### HDPE

High Density Poly Ethylene (HDPE) is a thermoplastic polymer made from petroleum. As one of the most versatile plastic materials around, HDPE plastic is used in a wide variety of applications, including plastic bottles, milk jugs, shampoo bottles, bleach bottles, cutting boards, and piping. Known for its outstanding tensile strength and large strength-to-density ratio, HDPE plastic has a high-impact resistance and melting point.

Besides its use for food applications, it can be found in places, including:

- Wood plastic composites
- Plastic surgery, specifically skeletal and facial reconstruction
- Snowboards
- Shoe Lasts
- 3-D printing filament
- Food and beverage containers

#### **What is Fiber Reinforced Plastic/Polymer (FRP)?**

- Fiber reinforced polymers are made of two primary constituents; fibers and a polymer matrix. In FRP, the fiber is embedded in a polymer matrix. This structure gives completely different chemical and physical properties than the properties of the individual materials. In fact, these materials satisfy higher engineering requirements than the ordinary materials. Hence composites are applied in less sophisticated to very sophisticate and demanding manufacturing tasks. Mechanical, civil, biomedical, marine, and the aerospace industries are main users of composite materials
- The primary role of fibers is to provide strength and stiffness to the material. But the fiber alone is brittle (ex: glass). Therefore, the fibers are encased in a coating of polymer materials. Polymer matrix holds the fibers in their position and transfers the loads between the fibers. It also contributes to the inter-laminar shear strength
- Polyester and vinyl are low cost materials, hence used extensively in commercial applications. Epoxies are used for high performance continuous fiber matrices. It also performs better than vinyl and polyester in high temperature conditions.

Bismaleimides and Polyimides are high temperature resin matrices for use in temperature critical engineering applications. Phenolics are high temperature resin systems with a good smoke and fire resistance; therefore, used in aircraft interiors.

#### **What is Glass Reinforced Plastic (GRP) / Glass Fiber Reinforced Plastic (GFRP)?**

- Glass Reinforced Plastic, commonly known as fiberglass, is a fiber reinforced polymer with glass fibers in the composite structure. The polymer is usually the epoxy, polyester, or the vinyl. Fiberglass materials are commonly used in high performance leisure aircrafts and gliders, boats, automobiles, bathtubs, hot tubs, water tanks, roofing products, pipes, cladding, cast, Surfboards, and external door skins.

#### **What is the difference between FRP and GRP?**

- FRP is a composite material, where high strength fibers are included in a polymer matrix. They are used in many commercial and engineering applications due to their high strength and light weight. FRP is widely used as a substitute for metal and wood. Best example is the use of carbon fiber reinforced polymer (CFRP) instead of aluminum and titanium or high grade steel in aircrafts.

- Fiberglass or GRP is a composite material made out of glass fibers and uses polyester, vinyl, or epoxy as the polymer. It is used to make gliders, boats, and bathtubs. Fiberglass is used mainly for commercial applications. Fiber glass is one type of FRP

#### **What is ARTIFICIAL Timber?**

Industrial timber is nothing but timber product manufactured scientifically in factories. Because of its scientific nature, it is stronger and durable than ordinary timber materials. It also contains desired shape and size.



#### **Different Types of Industrial Timber**

Following are the different form of industrial timber:Veneers

- Plywood
- Fiber boards
- Impreg timbers
- Compreg timbers
- Hard boards
- Glulam
- Chip board
- Block board
- Flush door shutters

#### **Veneers**

Veneers are nothing but thin layers of wood which are obtained by cutting the wood with sharp knife in rotary cutter. In rotary cutter, the wood log is rotated against the sharp knife or saw and cuts it into thin sheets. These thin sheets are dried in kilns and finally veneers are obtained. Veneers are used to manufacture different wood products like plywood, block boards etc.





### **Fig-veneers**

#### **PLYWOOD**

Ply means thin. Plywood is a board obtained by adding thin layers of wood or veneers on one above each other. The joining of successive layers is done by suitable adhesives. The layers are glued and pressed with some pressure either in hot or cold condition. In hot conditions 150 to 200°C temperature is maintained and hydraulic press is used to press the layers. In cold conditions, room temperature is maintained and 0.7 to 1.4 N/mm<sup>2</sup> pressure is applied. Plywood has so many uses. It is used for doors, partition walls, ceilings, paneling walls, formwork for concrete etc. Due to its decorative appearance, it is used for buildings like theaters, auditoriums, temples, churches, restaurants etc. in architectural purpose



Fig-Plywood

#### **FIBER BOARDS**

Fiber boards are made of wood fibers, vegetable fibers etc. They are rigid boards and called as reconstructed wood. The collected fibers are boiled in hot water and then transferred into closed vessel. Steam with low pressure is pumped into the vessel and pressure increased suddenly. Due to sudden increment of pressure, the wood fibers explode and natural adhesive gets separated from the fibers. Then they are cleaned and spread on wire screen in the form of loose sheets. This matter is pressed in between steel plates and finally fiber boards are obtained. Fiber boards are used for several purposes in construction industry such as for wall paneling, ceilings, partitions, flush doors, flooring material etc. They are also used as sound insulating material.



Fig-Fiber boards

#### **IMPREG TIMBERS**

Impreg timber is a timber covered fully or partly with resin. Thin layers of wood or veneers are taken and dipped in resin solution. Generally used resin is phenol formaldehyde. The resin solution fills up the voids in the wood and consolidated mass occurs. Then it is heated at 150 to 160°C and finally impreg timber develops. This is available in market with different names such as sungloss, sunmica, Formica etc. Impreg timber has good resistance against moisture, weathering, acids and electricity. It is strong, durable and provides beautiful appearance. It is used form making wood molds, furniture, decorative products etc.



Fig- Impreg timber

#### **COMPREG TIMBERS**

It is similar to impreg timber but in this case, the timber is cured under pressure conditions. So, it is more strengthened than impreg timber. Its specific gravity lies from 1.30 to 1.35.



Fig-Compreg Timber

**Hard Boards**

Hard board is usually 3 mm thick and made from wood pulp. Wood pulp is compressed with some pressure and made into solid boards. The top surface of board is smooth and hard while the bottom surface is rough. Hard boards are generally classified as three types as follows:

Types	Density (kg/m <sup>3</sup> )	Available thickness (mm)
Medium	480 – 800	6,8,10,12
Normal	800-1200	3.4.5.6.9.12
Tempered	>1200	3,4,5,6,9,12



Fig-Hardboards

**Glulam**

Glulam means glued and laminated wood. Solid wood veneers are glued to form sheets and then laminated with suitable resins. This type of sheet is very much suitable in the construction of chemical factories, long span roofs in sports stadium, indoor swimming pools etc. Curved wood structures can also be constructed using glulam sheets.



Fig-Glulam

**Chip Board**

Chip boards are another type of industrial timber which are made of wood particles or rice husk ash or bagasse. These are dissolved in resins for some time and heated. After then it is pressed with some pressure and boards are made. These are also called particle boards.



Fig-Chip board

### **Block Board**

Block board is a board containing core made of wood strips. The wood strips are generally obtained from the leftovers from solid timber conversion etc. These strips are glued and made into solid form. Veneers are used as faces to cover this solid core. The width of core should not exceed 25mm. If the width of core is less than 7mm then it is called as lamin board. Block boards are generally used for partitions, paneling, marine and river crafts, railway carriages etc.



Fig- Block boards

### **Flush door shutters**

Flush door shutters made in factories are widely using nowadays. They are generally available with 25mm, 30mm or 35mm thicknesses. Factory made flush board shutters are of different types such as cellular core, hollow core, block board core etc



Fig- Flush doors

## **MISCELLANEOUS MATERIALS**

### **Acoustic material**

When the sound intensity is more, then it gives the great trouble or nuisance to the particular area like auditorium, cinema hall, studio, recreation center, entertainment hall, college reading hall. Hence it is very important to make that area or room to be sound proof by using a suitable material called as 'Acoustic material'.

Acoustic material play a vital role in the various area of building construction. In studio, class room, reading hall, cinema theatre, more concentration is required to listen, hence the acoustics treatment is provided so as to control the outside as well as inside sound of the various building until such that sound will be audible without any nuisance or disturbance.

#### **Types of Acoustic Material**

- Acoustic plaster.
- Acoustic tiles.
- Perforated plywood.
- Fibrous plaster.
- Staw board.
- Pulp board.
- Compressed fibre board.
- Hair felt.
- Cork board slabs.
- Foam glass.

- Asbestos cement boards.
- Thermocoal.
- Foam plastic.
- Chip boards.
- Gasket cork sheet.
- Hair felt.
- Acoustic foam.

#### Properties of Acoustic Material

- Sound energy is captured and adsorbed.
- It has a low reflection and high absorption of sound.
- Higher density improves the sound absorption efficiency at lower frequencies.
- Higher density material help to maintain a low flammability performance. Hence acoustic material should have higher density.
- It controls the sound and noise levels from machinery and other sources for environmental amelioration and regulatory compliance.
- Acoustic material reduces the energy of sound waves as they pass through.
- It suppresses echoes, reverberation, resonance and reflection.

#### Uses of Acoustic Material

- Acoustic materials can be used for noise reduction and noise absorption.
- It makes the sound more audible which is clear to listen without any disturbances.
- It suppresses echoes, reverberation, reflection and resonance.
- Important specifications for noise reduction and noise absorption products include noise attenuation and noise reduction coefficient.
- A vinyl acoustic barrier blocks controls airborne noise (street traffic, voices, music) from passing through a wall ceiling or floor.
- Acoustic foam and acoustic ceiling tiles absorb sound so as to minimize echo and reverberation within a room.
- Sound proof doors and windows are designed to reduce the transmission of sound.
- Building techniques such as double wall construction or cavity wall construction and staggering wall studs can improve the sound proofing of a room.
- A sound proof wall (treated by a accurate material) can incorporate sound proofing and acoustic materials to meet desired sound transmission class (STC) values.

#### What is Wall Cladding?

- [Wall cladding](#) is a great way to protect a building from adverse weather elements, as well as other types of irritants that could have a negative effect on the building.
- Wall cladding is the process of layering one material on top of another material which will create a skin layer over the walls. Cladding is almost exclusively used as a control feature, preventing the walls and the internal workings of a room or building being damaged by water or allowing the leakage of water that could potentially become a hazard for people who are walking around inside of the structure.
- Depending on the task at hand, different types of materials can be used, such as wood, brick, metal plastic or imitation stone. Metal cladding is usually in the form of galvanized steel or aluminium.
- Advantages of Exterior Cladding
- The main advantage of using an exterior wall cladding is to protect a building form external damage while needing little to no maintenance. Once the wall cladding is in place, it will not need to be regularly checked or serviced like other weather protection measures have to be, costing time and money.
- If you have external cladding, if you care about aesthetics, it can be quickly washed down with water and it will look as good as new. One of the most common materials used is aluminium, as it is very durable and versatile, as well as lasting long into the future.



Fig- Wall cladding

## PLASTERBOARD

The primary **use** of **plasterboard** is to build partitions wall linings or ceilings in any building, ranging from hospitals and schools to shops and domestic properties. Newer, more innovative plasterboards can also be **used** for external sheathing purposes.



Fig- Plasterboard

## MICROSILICA

Microsilica is a byproduct from silicon metal or ferrosilicon industries, where these metals are produced in submerged electric arc furnaces. As the molten metal is produced, a silica-based gas is emitted. This gaseous fume, as it rises, cools rapidly and forms extremely minute, Amorphous, spherical particles. The micro silica fume is collected in a bag house, a system for filtering the hot air and gases vented from the furnace.

### Physical and Chemical Composition:

The physical characteristics of microsilica are quite different than other concrete components. but the chemical make-up is rather similar. Microsilica is an extremely fine particulate, with average particle diameter is 0.2-0.3  $\mu\text{m}$  , it is 100 times finer than cement particles.

Specific gravities of micro silica are low, about 2.2, because silica fume is an extremely fine material, its raw bulk densities are very low, varying from 300 to 600  $\text{kg}/\text{m}^3$ , after densified density will be 650  $\text{kg}/\text{m}^3$  to save freight fee.

### Application :

- Used in Ultra-High Performance Concrete;
- Used in Chemical Resistant Concrete;
- Used in Industrial Commercial Wear-resistant Flooring;
- Used in Marine Concrete;
- Used in Water Proof Concrete;
- Used in Shotcrete;
- Used in Reactive Powder Concrete (RPC);
- Used in Foam concrete block;



## Fig-Micro silica

### What is artificial sand?

Artificial sand, also called crushed sand or mechanical sand (m sand), refers to rocks, mine tailings or industrial waste granules with a particle size of less than 4.75 mm. It is processed by mechanical crushing and sieving.

In China, the artificial sand was mainly used in the construction of hydropower systems. For example, the Three Gorges Project and the Yellow River Xiaolangdi Project used artificial sand to prepare concrete. Due to the remote environment of the hydropower project and the high quality of sand and gravel, the projects have taken the materials locally.

Many Indian states have decreed the use of crushed sand in infrastructure construction because of its high compressive strength and cohesion and the adverse environmental effects of river sand mining, which will greatly boost the demand for artificial sand.



Fig- Artificial sand

### The factors that promote the development of artificial sand

There are both natural and human factors in the increasing demand for artificial sand. The former is that the natural sand is about to run out, while human factors include people's requirements for environmental protection and the need for high-quality concrete.

#### 1. Natural sand depletion

With the development of infrastructure, the natural sand resources formed by hundreds of thousands of years in many countries and regions have been almost exhausted, which has affected the further development of construction projects.

#### 2. The need for energy saving and environmental protection

**Reason 1:** River sand mining causes river pollution.

Driven by huge interests, natural sand has been indiscriminately mining, which changes the river course, affects the safety of river embankments, destroys the living environment of fish and contaminates the groundwater. The crushed stone sand is an important alternative resource to change this phenomenon.

**Reason 2:** River sand mining causes tailings.

In the process of mining river sand, it often produces a large amount of tailings which is not used reasonably. Especially in small mines, the tailings are piled up at random, occupying land and polluting the environment.

**Reason 3:** A lot of construction waste is wasted.

Besides, in urban planning and construction, a large amount of construction waste is generated, which actually can be crushed by the crushers to produce the artificial sand and aggregates for promoting resource utilization.

#### The need for the development of high-performance concrete technology

With the rapid development of concrete technology, the comprehensive performance of high-performance concrete and high-strength structural concrete has higher requirements on the quality of aggregates, requiring it with stable quality, good gradation and shape, while less and less natural sand meets the requirements. Therefore, people are turning their focus on artificial sand.

Artificial sand and mixed sand are mainly used in building construction, municipal construction, transportation, and other projects whose concrete strength grade is below C60. When meeting the corresponding technical requirements, they can also be used for concrete projects such as ports and water conservancy.

### BONDING AGENTS

Concrete bonding agents are natural or synthetic materials used to join the old and new concrete surfaces. This agent can also be used to join the successive concrete layers. This chemical helps to allow different concrete surfaces to behave like a single unit.

#### Functions of Concrete Bonding Agent

The cement present in a concrete mix does not have any bonding agent within it. When a layer of fresh concrete is added over an existing or old concrete layer, they exist as two separate layers without any bond. So a bonding agent must be introduced between the layers.

The use of a bonding agent helps the different concrete layers to behave like a single unit, thus increasing the strength and performance of the structure.

The bonding agent is applied over the existing surface of the concrete so that the new layer of fresh concrete successfully adheres to the old layer. The two main factors that affect the bonding between old and new concrete are:

Surface preparation and cleanliness of the existing surface

Strength and integrity of the old surface

#### Characteristics of Bonding Agents

The main characteristics of bonding agents are:

Bonding agents are easy to use and apply.

They reduce cracks formed in shrinkage

The permeability of concrete is reduced

#### How to Use Concrete Bonding Agent?

The application of bonding agent is performed by the following procedure:

Initially, the existing concrete surface is cleaned. Any dirt, dust, oil, efflorescence on the surface must be removed completely to facilitate the proper working of the bonding agent. Excessive dirt on concrete surfaces can be cleaned by pressure washing or vacuum shot blasting.

After the concrete surface is cleaned, the admixture is prepared. The chemical is shaken before use. It is diluted with water and mixed properly. It is always recommended to look through the manufacturer's guidelines to clearly follow the application procedures.

The next step is to properly mix the mixture. The manufacturer's guidelines would give an idea about the time within which the mix must be applied once the chemical is diluted with water.

A primary layer of bonding agent is applied on the existing surface over which the fresh concrete mix is placed. The concreting must be done before the primary coating starts to dry.

After placing the concrete layer, it is smoothed using a trowel and later cured

### **Different Types of Concrete Bonding Agents Used in Construction**

#### **1. Epoxy Bonding Agents**

This is an ideal resin for high performance and lightweight concrete parts. This resin wets-out fast. They impart high compressive strength, strong adhesion, and high chemical resistance. They are not only used to bond concrete layers but also to join concrete and steel.

#### **2. Acrylic Latex Bonding Agents**

This agent is primarily used to bond fresh concrete with a surface of old concrete. These are a combination of polymers and copolymers which is milky white in color. Acrylic latex bonding agents are applied on the surface either by brush, or trowels or rollers.

#### **3. Polyvinyl Acetate( PVA)**

This agent is mainly used for the repair works in concrete. PVA offers great water resistance, ultraviolet stability, and aging characteristics. It has gained popularity due to its compatibility with cement.



Fig.1. Application of Latex Bonding Agent

Adhesives can be defined as non-metallic materials capable of joining permanently to surfaces by an adhesive process. The use of adhesives in construction offers certain advantages over other binding techniques. These include the ability to bind different materials together, the more efficient distribution of stress across a joint, the cost-effectiveness of an easily mechanized process, and greater flexibility in design.

### **Different types of adhesives used in construction**

Adhesives may be found naturally or produced synthetically. There are different kinds of adhesives used in construction, some of them are given below.

#### **Polymer adhesives**

A polymer adhesive is a synthetic bonding substance made from polymers and is considered to be stronger, more flexible, and has greater impact resistance than other forms of adhesives. These bonding products are used in multiple industries including automotive, aerospace, aviation, construction, electronics, and electrical. Polymer adhesives are broadly classified as thermoplastic, or thermosetting, depending on the molecular structure. Many polymer adhesives are dispersed in water and are suitable for use with both solid and engineered wood flooring.



Fig- Polymer adhesives

#### **Hot melt adhesives**

Hot melt adhesive (HMA), is a form of thermoplastic adhesive that is commonly sold as solid cylindrical sticks of various diameters designed to be applied using a hot glue gun. The gun uses a continuous-duty heating element to melt the plastic glue, which the user pushes through the gun either with a mechanical trigger mechanism on the gun or with direct finger pressure. In industrial use, hot melt adhesives provide several advantages over solvent-based adhesives. Volatile organic compounds are reduced or eliminated, and the drying or curing step is eliminated. Hot melt adhesives have a long shelf life and usually can be disposed of without special precautions. Some of the disadvantages involve a thermal load of the substrate, limiting use to substrates not sensitive to higher temperatures, and loss of bond strength at higher temperatures, up to complete melting of the adhesive. Hot melt adhesives can also be applied by dipping or spraying, and are popular with hobbyists and crafters both for affixing and as an inexpensive alternative to resin casting.



Fig- Hot melt adhesives

#### **Acrylic adhesives**

Acrylic adhesives are key to large sections of modern industry, providing high strength bonds that work well as an alternative to rivets or other more mechanical joining techniques. Acrylic adhesives are useful for a wide range of surfaces, they can also be used to join acrylics. Acrylic adhesives are either thermoplastics, which can be moulded above a certain temperature or thermosetting polymer, which 'cure' once and cannot be remoulded. Acrylic adhesives have traditionally been used for their strong structural adhesive properties. As a good structural adhesive, acrylic adhesives are naturally in high demand. As an inexpensive structural adhesive, they can be very useful to very many projects! Acrylic adhesives also look good and bond easily to several different materials. This gives them great flexibility in terms of applications



Fig-acrylic adhesives

#### **Resin adhesives**

Resin adhesive provides superior bonding capabilities. It is manufactured in powdered, spray, emulsion, and liquid forms. Resin adhesives are used to enhance the retention of both composites and compomers and hence prevent bacterial microleakage. It can be used with various materials, including, wood, fabric, glass, china or metal. It's important to note, however; the epoxy resin is not considered to be water-resistant. Repeated moist or wet conditions can cause deterioration over time which will affect durability.

#### **Anaerobic adhesives**

Anaerobic adhesives are one-part adhesives composed of dimethacrylate monomers that cure only in the absence of air. They are less toxic than other acrylics, have a mild, inoffensive odor, and are not corrosive to metals. Anaerobic adhesives are stored in partially filled polyethylene containers, in which the ratio of air-exposed surface to volume is high. Anaerobic adhesives are used for structural bonds, primarily with materials such as metals and glass and to a lesser extent, wood and plastic (thermosets and some thermoplastics). An activator is applied to one or both joint surfaces; adhesive is then applied to one surface to begin curing. Joints produced using anaerobic adhesives can withstand exposure to organic solvents and water, weathering, and temperatures of up to about 200°C





Fig- Anaerobic adhesives

**Resin adhesives**



**Epoxy adhesives**

Epoxy adhesives can adhere to a wide variety of materials, their high strength, their resistance to chemicals and environments, and their ability to resist creep under sustained load, epoxies are the most widely used structural adhesive. They are available in one component, heat curing and two-component, room temperature curing systems. Unmodified epoxies cure hard, brittle solids. Most adhesive formulations include modifiers to increase the flexibility or toughness of the cured adhesive. This results in bond lines that can resist more peel and cleavage stress as well as impact. As the most widely used structural type adhesive, epoxy adhesives are commonly offered as either one component or two-component systems. One component epoxy adhesives are generally cured at temperatures between 250-300°F, conditions that engineer a product of high strength, excellent adhesion to metals, and outstanding environmental and harsh chemical resistance.



Fig- epoxy adhesives

### **Pressure adhesives**

Pressure adhesives remain viscous. As a result, they remain permanently tacky and can wet surfaces on contact. Bonds are made by bringing the adhesive film in contact with the substrate and applying pressure. If inadequate pressure is applied or the processing temperature is too low, bonding faults such as bubbles or detachment can occur. Since these adhesives are not true solids, the strength of pressure-sensitive adhesives decreases when the temperature is increased. Pressure-sensitive adhesives also tend to undergo creep when subjected to loads. They are typically formulated from natural rubber, certain synthetic rubbers, and polyacrylates.



Fig-Pressure adhesives

### **Electrically conductive adhesives**

Modern electrically conductive adhesives provide excellent adhesion and reliability. They cure in times of less than two minutes, and in-line processing capability for exceptionally high throughput. An electrically conductive adhesive is an adhesive made of conductive particles suspended in a sticky compound. With about 80% of the mass of the adhesive made of the conductive particles, they are spaced closely enough to each other to allow a substantial current to pass. The composition of conductive adhesives can vary greatly from one product to another. The base adhesive is typically a 2-component epoxy, although acrylate and polyester are also quite common. The conductive component plays a huge role in determining the cost of a conductive adhesive: inexpensive ones use iron, which has poor conductivity, while the most expensive ones use either silver or copper.

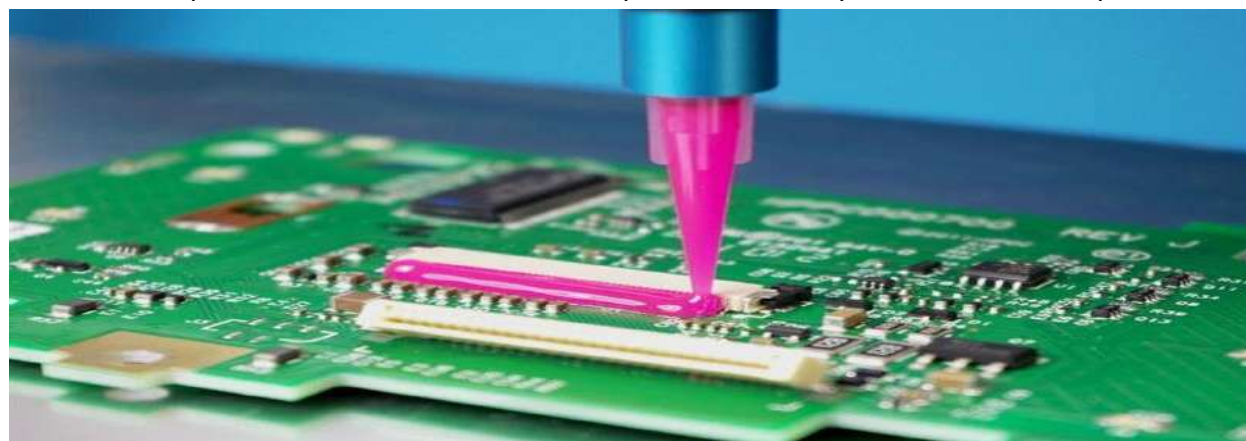

Fig- Electrically conductive adhesives

### **Phenolic resin adhesives**

Phenolic resin adhesives are the condensation products of phenol and formaldehyde and are an important class of adhesives. They are relatively inexpensive and are manufactured as liquid compositions and films. Thermosetting phenolic resins withstand high temperatures both under mechanical load and in severe environments with minimal deformation and creep. The primary use of phenolic resins is as a bonding agent. Phenolic resins readily penetrate and adhere to many organic and inorganic fillers and reinforcements, and when cross-linked throughout the fillers and reinforcements, provide excellent mechanical, thermal, and chemically resistant properties. Their exceptional compatibility with cellulose fillers makes them the ideal binder for particleboard, plywood, hardboard, and oriented strand board (OSB).



Fig- Phenolic resin adhesives

### **Plastisol adhesives**

Plastisol are single-component adhesives that are applied as a paste to the substrate. The paste consists of solid polyvinyl chloride (PVC) particles dispersed in plasticizer. To form a bond, the applied adhesive is heated so that the thermoplastic PVC swells and can take up the plasticizer. Plastisols have high flexibility and good peel resistance. They can be flexible or rigid depending on the type and amount of plasticizer added and give good adhesion to most types of (oiled) metals, and plastics. They are often the preferred material for applications where low-flammability at a low cost is required or advantageous. They are also easy to apply, require no meter mixing, and allow for fast processing.

#### **Reactive adhesives**

Reactive adhesives require a chemical reaction for bonding two surfaces. These adhesives are classified into one- and two-component reactive adhesives and have been used in applications where substrates require substantial permanency and high strength adherence such as high-tech devices. Highly reactive adhesives with quick gelling and hardening behavior and steep increases in bonding strength even at a low degree of chemical curing. Its mixes are produced by including accelerators, special hardeners, crosslinkers and other materials.



Fig- Reactive adhesives

#### **Plastisol adhesives**



#### **Solvent-Based adhesives**

These are called binding agents and are dispersed in an organic solvent. When the solvent evaporates, the adhesive changes from liquid to its final solid form – the pure bonding substance remains. The function of the relatively highly volatile solvents is to facilitate easy transport and application of the adhesive: They ensure that the binding agents stay liquid and can, therefore, be processed. Also, the solvents influence key adhesive characteristics such as adhesion, by promoting the wetting of the substrate or by biting the substrate surface or dwell time and open time, depending on how fast they evaporate. The performance of solvent-based adhesives is largely determined by the polymer system in the formulation. The choice of adhesive type depends on the specific substrates and environmental resistance needed – temperature resistance, oil and plasticizer resistance, etc



#### **Thermoset adhesives**

Thermoset adhesives are crosslinked polymeric resins that are cured using heat and/or heat and pressure. Due to their superior strength and resistance, thermosets are widely used for structural load-bearing applications. Thermoset adhesives have very high strength, excellent gap filling ability, and resistance to moisture and heat. Most thermoset adhesives are supplied as a two-component system although one-part adhesives are used as well. Two-component adhesives are typically made up of a resin and a hardener, in liquid or gel form, which are mixed to initiate the curing process.

#### **UV Curing adhesives**

UV glue curing is gaining popularity over other methods of bonding such as drying or exposure to chemicals. Bonding with heat or drying works by evaporation, which can be inconsistent and can also take time for the inks to dry. Chemical treatment can be costly to purchase materials and may expose employees to harmful inhalants or respiratory contaminants. UV glue curing is quick and consistent, providing an instantly hardened surface with no harmful chemical exposure. One big advantage to the finishes with UV curing is that it dries clear, allowing multiple layers if need be while sanding down the finish will provide an invisible 'liquid plastic' unbreakable bond. Paint or stain can be applied to the finish, giving endless options for applications with various products.



#### **Thermoset adhesives**

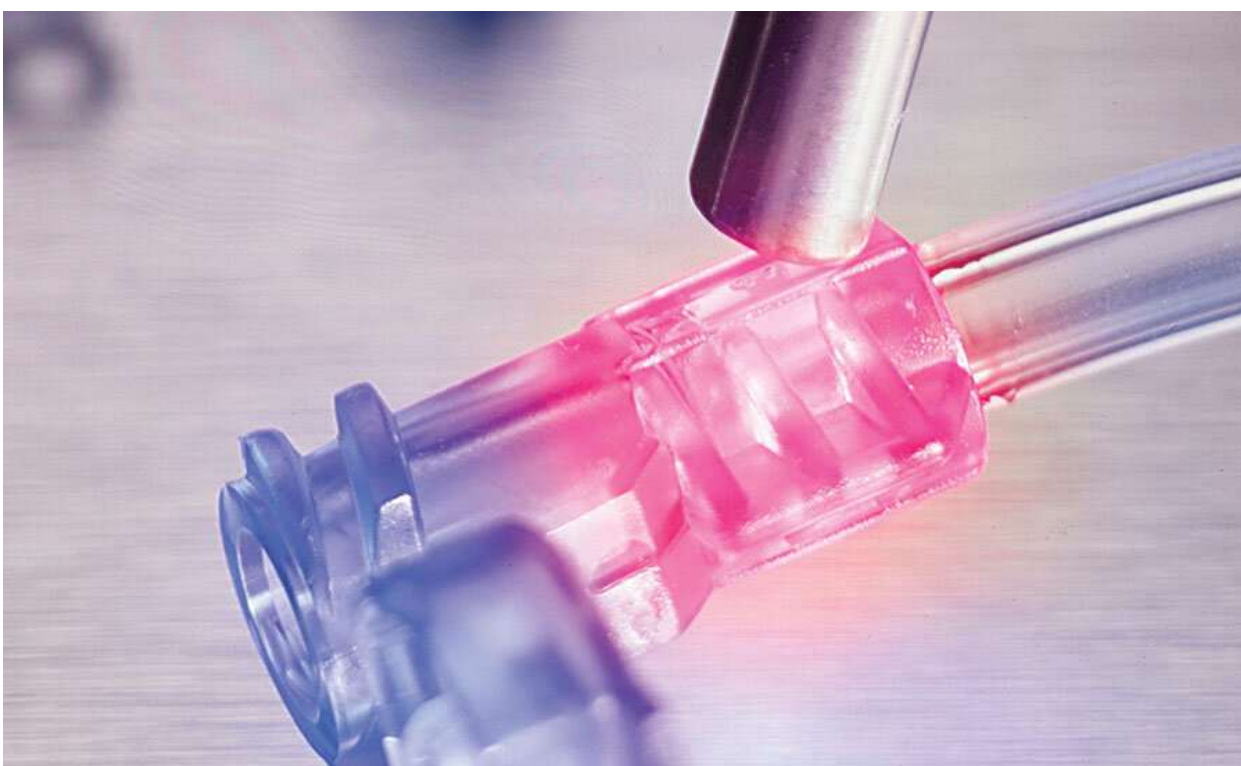

#### **UV Curing adhesives**

#### **Water-based adhesives**

Water-based (or more commonly referred to as waterborne) adhesives are typically formulated from natural polymers and soluble synthetic polymers. These adhesives may be supplied as solutions or formulated as dry powders which must be mixed with water before application. The strength of the adhesive is attained when water is lost from the glue line by evaporation or absorption by the substrate. Because of this requirement, the use of these adhesives requires that at least one substrate is permeable. Where neither substrate is permeable, it is possible to apply a thin coat of adhesive, allow it to dry, and then activate the adhesive by lightly wiping with a wet brush or roller or spraying with water.

**Conclusion**

With rapid evolution, the adhesive manufacturers are spending on research and development for the compilation of properties of two or more materials to get the required results. With time and during their development, adhesives have gained a stable position in an increasing number of production processes.

## CHAPTER 2 PREFABRICATION

### COURSE-CONTENT

2.1 Introduction, necessity and scope of prefabrication of buildings, history of prefabrication, current uses of prefabrication , types of prefabricated systems, classification of prefabrication, advantages and disadvantages of prefabrication

2.2 The theory and process of prefabrication, design principle of prefabricated systems, types of prefabricated elements, modular coordination

2.3 Indian standard recommendation for modular planning

#### Introduction

**Prefabrication** is the practice of assembling components of a [structure](#) in a [factory](#) or other [manufacturing](#) site, and [transporting](#) complete assemblies or sub-assemblies to the [construction](#) site where the structure is to be located. The term is used to distinguish this process from the more conventional construction practice of transporting the basic materials to the construction site where all assembly is carried out.

#### Necessity of prefabrication

Estimates made by studies indicate that India needs to add 700 to 900 million square metres of built space annually, in the urban areas to take care of the needs of shelter, healthcare, education, industry, trade and commerce, institution, entertainment, leisure, transportation etc. for the population, preferring urban areas as their habitat. Considering the huge task of creating enormous built space, India needs to explore new, innovative and state of art construction technologies to meet the defined targets. Considering the physical, environmental and economic implications, construction sector needs to be made more effective and efficient by using state of art construction technologies. In search for appropriate solutions to promote cost- effective, resource-efficient, sustainable and eco-friendly construction, paper looks at the option of pre-fabrication as an approach , which can go a long way in making building construction more rational in terms of cost, time, economy, quality, sustainability, resources, material etc. In addition, paper also looks at the ways and means to make pre- fabrication more qualitative, cost-effective and energy-efficient for promoting state of art sustainable built environment.

#### Traditional on -site construction-Issues

Majority of construction taking place now in India follow the traditional on-site pattern of construction. Traditional on-site construction is described as linear construction, where each individual step is not only constructed entirely/ largely on site, but also needs to be completed before the project can move on to the next phase. Such construction has major implications in terms of time, cost, quality, safety, noise, pollution, manpower etc which can be defined as;

- Majority of building components constructed entirely/ largely on site,
- Linear construction- where each step needs to be completed before taking up next.
- Considerable time taken for construction- Highly time consuming-time intensive
- Generation of large scale waste- waste intensive
- Construction schedule largely dictated by prevailing weather conditions.
- Generation of lot of pollution, traffic, noise and dust- pollution intensive
- Unsafe for the workers deployed in construction.
- Needs lot of manpower for making and supervision of building operation- manpower intensive
- Material storage facilities at site
- Creation of accommodation for workers deployed at construction
- Loss/theft of material from site
- Large variation in quality- largely dependent on work force deployed
- Use of lot of water/energy – resource intensive- Grey Buildings
- Increased initial cost of construction- cost inefficient
- Uneconomical in cost and resources- cost overrun
- Delayed return on project
- Large inventory of material- material intensive
- Unpredictable project schedule- Construction inefficiency
- Limited application in hazardous areas
- Large site disruption
- Adverse impact on surroundings
- Totally constructed/Individual/human oriented

#### SCOPE OF PREFABRICATION OF BUILDINGS

Looking at the entire context of on-site construction, it was considered prudent that instead of on-site construction, off-site/modular constructions offers enormous opportunities , which not only overcomes the disadvantage of traditional construction, but also offer distinct advantages in terms of cost, time, quality, safety, environment, materials etc. Off-Site construction is a process that incorporates pre-fabrication and pre-assembly. It involves creating individual building components off site in a designated factory, shipping said parts to the plot of land and installing the components to create a finished structure Off-site fabrication requires a project strategy that changes the orientation of the project process from construction to [manufacture](#) to installation. This method of construction differs significantly from basic methods and offers numerous benefits for both the building owner and the construction agency. Despite distinct advantages prefabrication, as a process, has its limitations also. Prefabrication is bad for

making last-minute changes. It's good for making when project is fine tuned to last detail before starting. When done correctly, off-site construction can benefit a project's schedule, budget and skilled labour requirements

### HISTORY OF PREFABRICATION

Prefabrication has been used since ancient times. For example, it is claimed that the world's oldest known engineered [roadway](#), the [Sweet Track](#) constructed in [England](#) around [3800 BC](#), employed prefabricated timber sections brought to the site rather than assembled on-site.



[Sinhalese](#) kings of ancient [Sri Lanka](#) have used prefabricated buildings technology to erect giant structures, which dates back as far as 2000 years, where some sections were prepared separately and then fitted together, specially in the [Kingdom](#) of [Anuradhapura](#) and Kingdom of [Polonnaruwa](#).



Figure 5: Luxor Temple [10]



Figure 6: Image showing the fixing detail of stone Baluster and Railing Vedic Railing [10]

In 19th century Australia a large number of prefabricated houses were imported from the United Kingdom.

The method was widely used in the construction of [prefabricated housing](#) in the 20th century, such as in the [United Kingdom](#) as temporary housing for thousands of urban families "bombed out" during [World War II](#).



"Loren" Iron House, at [Old Gippstown](#) in [Moe](#), Australia

### CURRENT USES OF PREFABRICATION

- The most widely used form of prefabrication in building and [civil engineering](#) is the use of prefabricated [concrete](#) and prefabricated [steel](#) sections in structures where a particular part or form is repeated many times. It can be difficult to construct the [formwork](#) required to [mould](#) concrete components on site, and delivering wet concrete to the site before it starts to set requires precise time management. Pouring concrete sections in a factory brings the advantages of being able to re-use moulds and the concrete can be mixed on the spot without having to be transported to and pumped wet on a congested construction site. Prefabricating steel sections reduces on-site cutting and [welding](#) costs as well as the associated hazards.
- Prefabrication techniques are used in the construction of [apartment](#) blocks, and housing developments with repeated housing units. The quality of prefabricated housing units had increased to the point that they may not be distinguishable

from traditionally built units to those that live in them. The technique is also used in office blocks, warehouses and factory buildings. Prefabricated steel and glass sections are widely used for the exterior of large buildings.

- Detached houses, cottages, log cabin, saunas, etc. are also sold with prefabricated elements. Prefabrication of modular wall elements allows building of complex [thermal insulation](#), window frame components, etc. on an [assembly line](#), which tends to improve quality over on-site construction of each individual wall or frame. Wood construction in particular benefits from the improved quality. However, tradition often favors building by hand in many countries, and the image of prefab as a "cheap" method only slows its adoption. However, current practice already allows the modifying the floor plan according to the customer's requirements and selecting the surfacing material, e.g. a personalized brick facade can be masoned even if the load-supporting elements are timber.
- Prefabrication saves engineering time on the construction site in civil engineering projects. This can be vital to the success of projects such as bridges and [avalanche galleries](#), where weather conditions may only allow brief periods of construction. Prefabricated bridge elements and systems offer bridge designers and contractors significant advantages in terms of construction time, safety, environmental impact, constructibility, and cost. Prefabrication can also help minimize the impact on traffic from bridge building. Additionally, small, commonly used structures such as [concrete pylons](#) are in most cases prefabricated.
- Radio towers for mobile phone and other services often consist of multiple prefabricated sections. Modern lattice towers and guyed masts are also commonly assembled of prefabricated elements.
- Prefabrication has become widely used in the assembly of [aircraft](#) and [spacecraft](#), with components such as wings and fuselage sections often being manufactured in different countries or states from the final assembly site. However, this is sometimes for political rather than commercial reasons, such as for [Airbus](#).



Transportation of prefabricated Airbus wing assembly



A house being built with prefabricated concrete panels.

#### **TYPES OF PREFABRICATED SYSTEMS**

**Modular:** three-dimensional components built almost entirely in a factory environment and delivered to the site for installation.

**Panelized:** 2D panel homes will partially install in a factory environment. after that, it will deliver to the site for assembly and construction.

**Hybrid Prefab:** A combination of 2D panel and 3D modular construction.

#### **CLASSIFICATION OF PREFABRICATION**

The Prefabrication is classified as follow from the view of degree of Precast construction.

1. Small prefabrication
2. Medium Prefabrication



3. Large Prefabrication
4. Cast in Site Prefabrication
5. Off-Site (or) factory Prefabrication
6. Open system of prefabrication
7. Closed system of prefabrication
8. Partial prefabrication
9. Total prefabrication

1.Small Prefabrication : The first 3 types are mainly classified according to their degree of precast Elements using in that construction for eg.:brick is a small unit precast and used in building. This is called as small prefabrication. That the degree of precast element is very low.

2. Medium Prefabrication : Suppose the roofing systems and horizontal members are provided with prestressed elements those construction are known as medium prefabricated construction here the degree of precast elements are moderate.

3.Large Prefabrication : In large prefabrication most of the members like wall panels, roofing / flooring Systems, beams and columns are prefabricated. Here degree of precast elements are high.

4.Cast – in – site prefabrication and off site prefabrication : One of the main factor which affect the factory prefabrication is transport. The width of walls, mode of transport, vehicles are the factors which prefabrication is to be done on site or factory. Suppose the factory situated at a long distance from the construction site and the vehicle have to cross a congested traffic with heavy weighed elements the cost in site prefabrication is preferred .Off site prefabrication is preferred only when number of houses are more and the conveyance is easier with normal type of lorry and trailers. Therefore we can adopt factory (or) OFF site prefabrication for this type of construction.

6.Open system of prefabrication : In the total prefabrication systems, the space framers are casted as a single unit and erected at the site. The wall fitting and other fixing are done on site. This type of construction is known as open system of prefabrication.

7.Closed system of prefabrication : In this system the whole things are casted with fixings and erected on their position.

8.Partial prefabrication : In this method of construction the building element (mostly horizontal) required are precast and then erected. Since the costing of horizontal elements (roof / floor) often take there time due to erection of form work the completion of the building is delayed and hence this method is restored. In most of the building sites this method is popular more. Use of double tees, channel units, cored slabs, hyperboloid shall etc., are some of the horizontal elements. This method is efficient when the elements are readily available when the building reached the roof level. The delay caused due to erection of formwork, delay due to removal eliminated completely in this method of construction Suitable for any type of building provided lifting and erection equipments are available.

9. Total Prefabrication : Very high speed can be achieved by using this method of construction. The method can be employed for frame type of construction or for panel type of or the total prefabrication can be on site or off-site. The choice of these two methods depend on the situations when the factory produced elements are transported and erected site we call it off-site prefabrication. If this method is to be adopted then we have a very good transportation of the products to site. If the elements are cast near the building site and erected, the transportation of elements can be eliminated, but we have consider the space availability for establish such facilities though it is temporary. The choice of the method of construction also depends on the following;

1. Type of equipment available for erection and transport.
2. Type of structural scheme ( linear elements or panel)
3. Type of connections between elements.
4. Special equipment devised for special method construction.

#### **ADVANTAGES OF PREFABRICATION**

##### **1.Building in Hazardous Area**

Prefabrication has distinct advantages in remote area, areas prone to disasters, areas hit by disasters, where accessibility and availability of manpower, transportation of materials and time available for construction is minimal. In such cases pre-fabrication, offers the best option which can help in creating construction in minimum possible time at minimal cost. Further in hill areas, which suffer from extreme climatic conditions, pre-fabrication can also help in creating well insulated structures, making them least susceptible to extreme outside climate. Leh, Ladakh, Lahaul, Spiti etc are the areas where pre-fabrication is the best option for construction.

##### **2.Assured Quality Construction**

Since pre- fabrication has genesis in construction of majority of building components in industrial setting, under highly controlled environment, involving lot of quality checks and balances, the components produced are accordingly of assured uniform quality unlike site-built structures which are totally dependent upon varying skill levels and the schedules of independent contractors . Modular buildings are invariably manufactured to code, making owners free from the worry of quality, saving of time and energy involved in supervision, which is a major issue in the traditional method of on-site construction.

##### **Material Efficiency**

Prefabricated buildings are known for their material efficiency both onsite and off-site.. These buildings do not produce waste, since all the required material for construction arrives in the finished state on site. Since the components are produced in the factory, they leave/ create very little waste during the manufacturing, assembly, disassembly and the construction process which involves just putting together all components as per approved design. Further, since no material is brought to site ,as in the onsite construction, there is no wastage due to human operations and loss of material due to theft etc.

##### **Cost- Efficiency**

Greatest advantages of prefabricated construction lies in its capacity to promote economy and cost- efficiency, which is generally achieved through; large discounts received from material suppliers, reduction in construction time, mass production of components and economy achieved through standardisation, repetitive nature of operations and large scale operations.

Reduction of wastage and in-house recycling of the extra materials also lowers down cost of components. Despite the fact, pieces being custom-made, modular construction remains inexpensive due to lower time frame prefabricated construction takes as compared to traditional construction and the financial advantage made due to saving more money on [construction financing](#). In addition, factory setting of the prefabrication, increased controls, better material planning, reduced material surplus calling for **less storage cost**, **less material loss** from damage or pilferage; **saving on labour hours and manpower cost** in construction of building without weather constraints and on-site/off-site work done simultaneously

#### **Green Construction**

Though modular buildings do require a lot of power consumption at the manufacturing site, but compared to traditional constructions, they are lot more eco-friendly, both in the long and short-term. Prefabricated buildings have lower life cycle energy implications as compared to on-site construction due to optimum consumption of materials, assembly, disassembly and recycling of the building components. As they are made inside a factory, any waste or extra material is easily recycled. Prefab buildings have minimum requirement of water due to absence of onsite watering of brick/concrete works making them least consumers of resources. Energy efficiency in prefab buildings is being achieved through using recycled materials, LED lighting and installing solar panels and better wall-insulation, leads to energy savings in the long run. Prefabrication/modularization is also becoming more widely recognized as a resource-efficient and greener construction process due to reduced material waste and pollution besides increased use of recycled materials

#### **Flexibility**

Flexibility is one of the distinct advantage provided by the modular construction based on easy dismantling and relocation of buildings to different sites, reducing wastage, reduced demand for raw materials, minimum expended energy and decreased time. Considering the fact prefabricated construction units can be used in different spaces, it can easily blend neutrally in any building typology. Prefabricated structures, being made of numerous individual parts, also permit higher amount of flexibility in building structure/ design by changing the design of the specific prefab component.

#### **Reduced Site Disruption**

Traditional construction, involves major site disruption for the reason that all building processes are performed on site including transporting/storage/mixing of materials, water storage, creating residential space for labour etc whereas prefabricated construction takes much of these disruptions away from the site and limit the noise, pollution, waste and other common irritants. Since many components of a building are completed in the factory, there is significantly less truck traffic, equipment and material suppliers around the final construction site.

#### **Time Efficiency**

Prefab/ modular construction are known for their time efficiency to build, than on-site construction taking, in many cases, less than half the time when compared to traditional construction, due to better planning, reduced site disruptions and quicker fabrication of multiple components. This permits construction companies to take on multiple projects simultaneously, allowing businesses to grow and make larger profits. Due to reduced on-site construction, requirement of manpower and their supervision is considerably reduced leading to high degree of construction efficiency. Role of experts visiting the site is also minimised leading to higher operational efficiency. In pre-fabrications, building components are produced on a defined schedule, donot require any operation for finishing on site including watering of concrete/ brick walls, seasoning of wood, painting and polishing of wood/door etc, which minimises the time span for construction

#### **Safety**

Prefab construction is known for overall safety of the building after construction including safety of workers at site during construction. The risks and dangers of outside construction posed by hazardous sites, weather, etc., are mostly neutralized by the fact that the components are mostly manufactured in a controlled and safe environment

#### **Limitations imposed by the Prefab Buildings;**

Despite numerous advantages which prefab construction hold, it has few limitations which are enumerated below

#### **Monotony**

Limitations imposed by the materials and the process used in the mechanisation of building products, has led to imposing numerous restrictions on the designers in creating state of art buildings. Based on the concept of mass production and standardisation, prefab buildings suffer from lack of design innovations and look monotonous.

#### **Restricting additions and alterations**

In addition to being monotonous, prefab buildings donot provide enough options to owners/tenets to make any change which may be necessitated, considering the changing physical, social and economic conditions. This generally leads to non-acceptability of the prefab buildings.

#### **Reduced Resale Value**

Dictated by monotony and limited options for additions and alterations, prefab structures donot find many buyers in the resale market and accordingly command very low premium. Further the general perception of the people hovering around that pre-fab buildings are of lower quality, also put these them in poor light and reduce their resale value.

#### **Roadblock in Financing**

Considering the fact that prefab buildings are constructed differently from traditionally buildings, accordingly, their funding requirements are also at variance from traditional buildings. In prefab buildings, since most of the products are manufactured off-site in a factory, accordingly, it is difficult to understand and evaluate the progress of buildings on site. In the traditional system, funding of projects is generally linked to the stages/progress of the construction. In the prefab buildings, this system does not hold good and cannot apply for the reasons of constructions being done off-site and majority of payments are required to be made upfront. Accordingly, financial institutions feel reluctant to give loans/advances for such buildings, creating disincentives for the buyers to go for such buildings

#### **. High Transportation Cost**

Since majority of building components are manufactured off-site in the factory and these components are in the finished mode, having large volume and weight, therefore, they require specialised system of transportation to make sure the products donot suffer any damage during the loading, unloading and transportation. Accordingly, transportation cost in the prefab buildings are invariably high as compared to traditional buildings where the building materials can be packed more densely. In addition, large prefabricated sections would be requiring heavy machinery involving cranes and precision measurement and handling during loading, transportation and placing them in position, making them cost-intensive and unattractive. Besides high transportation cost, special vehicles are required to transport the building products calling for wide-bodied mobile vans and wide roads to facilitate their movement. Sustainability also emerges as a major issue during the transportation of the [materials](#) to the [construction site](#) due to cost and energy involved in transportation.

#### **Accuracy and Precision**

Prefabricated buildings require high degree of accuracy in manufacturing components besides working out the detailed design. Once the production starts, there are limited option of additions/alterations/changes, which if needed, will require huge cost and dilute all the saving in cost/time which prefab buildings command. High degree of precision is also required in the manufacturing of components because they are all made fit to size. Any variation in size will lead lot of complication/cost/time in replacement. It is rightly said, 'A mistake in the mass production of [prefabricated elements](#) ahead of the measurable site work is a serious risk"

#### **Mass Production**

Since prefab/modular structure is based on mass production, accordingly it requires an industrial setup with appropriate knowledge, machinery, technical manpower and expertise, which in turn is expensive and requires huge upfront investment. So prefab can only work if the industrial base for mass production is available in place. Creation of such base requires time and resources and a policy framework. Further mass production works on economy of scale and accordingly, for achieving economy, constant flow of order has to be ensured. In the absence of any assured inflow of order no mass production will be feasible and economically viable. However, looking at the entire context there exists dichotomy between industrial production and construction because factory production requires predictable and consistent demand, whereas [construction](#) tends to require large numbers at the same time, then none. In addition, mass production will only succeed if there is a constant and adequate demand. Which means they are more viable near large urban centres or where large scale new construction is to come up. Its existence away from small centres, where there is periodic and limited demand - transportation cost may dilute the total process of prefab construction.

#### **Skilled Manpower and Cost**

Modular construction requires large skilled manpower, both at production and assembly site, along with machinery and infrastructure to complete the project, which in the developing countries is difficult to find across the board, which limits its application. Cost effectiveness to a large extent may not be achieved always due to additional [cost](#) involved in temporary bracing for transportation and/or lifting or permanent framing to support [prefabricated assemblies](#) besides [cost](#) involved in the pre-[assembly](#) in factory prior to [dismantling](#) for [transport](#) and delivery.

#### **Process and theory**

An example from house-building illustrates the process of prefabrication. The conventional method of building a house is to transport bricks, timber, cement, sand, steel and construction aggregate, etc. to the site, and to construct the house on site from these materials. In prefabricated construction, only the foundations are constructed in this way, while sections of walls, floors and roof are prefabricated (assembled) in a factory (possibly with window and door frames included), transported to the site, lifted into place by a crane and bolted together.

Prefabrication is used in the manufacture of ships, aircraft and all kinds of vehicles and machines where sections previously assembled at the final point of manufacture are assembled elsewhere instead, before being delivered for final assembly.

The theory behind the method is that time and cost is saved if similar construction tasks can be grouped, and assembly line techniques can be employed in prefabrication at a location where skilled labour is available, while congestion at the assembly site, which wastes time, can be reduced. The method finds application particularly where the structure is composed of repeating units or forms, or where multiple copies of the same basic structure are being constructed. Prefabrication avoids the need to transport so many skilled workers to the construction site, and other restricting conditions such as a lack of power, lack of water, exposure to harsh weather or a hazardous environment are avoided. Against these advantages must be weighed the cost of transporting prefabricated sections and lifting them into position as they will usually be larger, more fragile and more difficult to handle than the materials and components of which they are made.

#### **Design Principle of Prefabrication:**

The Main reasons to choose Precast Construction method over conventional in method.

- Economy in large scale project with high degree of repetition in work construction.
- Special requirement in finishing.
- Consistency in structural quality control.
- Fast speed of construction.
- Constraints in availability of site resources(e.g. materials & Laborites )
- Other space & environmental constraints.
- Overall assessment of some or all of the above factors which points to the superiority of adopting precast construction over convention method.

The main reasons to choose. Precast Construction method over conventional in situ method.

1. Economy in large scale project with high degree of repetition in work execution.
2. Special architectural requirement in finishing.
3. Fast speed of construction.
4. Constraints in availability of site resources e.g. materials & labour etc..
5. Other space & environmental constraints.
6. Overall assessment of some or all of the above factors which points to the superiority of adopting precast construction over conventional method

**Modular coordination**

Modular coordination is a concept for coordinating dimensions and space for which building, components are positioned. Basic unit of MC is module 1M which is equal to 100mm. MC is internationally accepted by the International Standard of Organization (ISO). The introduction of MC in building facilitate proper planning, design construction and assembly of building components. The principle objective of implementation of MC is to improve productivity, more flexibility in design and construction activities.

**Modular co-ordination Grid:**

**Structural Grid:**

It is used to locate the structural components such as beam and columns.

**Planning Grid:**

It is used for locating the space for building components like rooms.

**Controlling Grid:**

It is used for locating internal walls. Modular coordinated grid is used for locating the building components and the grids can be available in both horizontal and vertical planes. The grids are generated by measurement in modules.

**Dimensional Grid:**

Modular coordinated grid network defines the space available for placing the components. An important factor is that the component must always undersized to grid size for providing space for joint space. Manufactured length of unit nominal length 11 ½ inch grid size would be 12 inch because of units were designed to be placed with ½ inch joints.

In modular coordination system, in place of geometric series, a different system of preferred dimensions is used. For larger dimensions it is represented in modules like 1M=0.1m, for smaller dimensions sub modular increments 50mm or 25mm are used.

**Modular coordination system provides,**

- Defined coordinated spaces for building elements and components.
- Rules for maintaining the component size while manufacturing
- Rules for selecting the component size and providing the required grid size in building.
- The MC system allows standardization in design of building components, it encourages manufacturers and assemblers to enter in open market.
- It is difficult to manufacture the component in SI unit mm tolerance. But it is easier for manufacturer to make in module tolerance system.

### **Advantages of Modular Coordination:**

- Facilitate cooperation between building designer, manufacturer, traders, contractors.
- Improves freedom in design and permits flexibility.
- Encourages the possibility of interchanging the components.
- Simplifies positioning and placing of components
- Ensures dimensional coordination between component with the rest of the building.
- It is possible to get maximum economy in the production of components.
- Reduces the need for making special sizes.
- Increases the number of choices of components because of interchangeability.
- Improves quality and productivity of construction.
- Wastage in production and time taken for installation of components is reduced.
- It helps to achieve the responsibility in constructing the building.

### **Prefabrication Elements :**

- Flooring / Roofing system.
- Priciest Beams

- Precast Columns
- Precast walk panels.
- recast Stabs.

## CHAPTER 3

### EARTHQUAKE RESISTANT CONSTRUCTION

#### COURSE CONTENT

3.1 Building Configuration

3.2 Lateral Load resisting structures

3.3 Building characteristics

3.4 Effect of structural irregularities-vertical irregularities, plan configuration problems.

3.5 Safety consideration during additional construction and alteration of existing Buildings.

3.6 Additional strengthening measures in masonry building-corner reinforcement, lintel band, sill band, plinth band, roof band, gable band etc.

- To avoid a great earthquake disaster with its severe consequences, special consideration must be given. Engineers in seismic countries have the important responsibility to ensure that the new construction is earthquake resistant and also, they must solve the problem posed by existing weak structures.
- Most of the loss of life in past earthquakes has occurred due to the collapse of buildings, constructed with traditional materials like stone, brick, adobe (kachcha house) and wood, which were not particularly engineered to be earthquake resistant. In view of the continued use of such buildings, it is essential to introduce earthquake resistance features in their construction.
- The problem of earthquake engineering can be divided into two parts, first to design new structures to perform satisfactorily during an earthquake and second to retrofit existing structures so as to reduce the loss of life during an earthquake. Every city in the world has a significant proportion of existing unsafe buildings which will produce a disaster in the event of a strong ground shaking. Engineers have the responsibility to develop appropriate methods of retrofit which can be applied when the occasion arises.
- The design of new building to withstand ground shaking is prime responsibility of engineers and much progress has been made during the past 40 years. Many advances have been made such as the design of ductile reinforced concrete members. Methods of base isolation and methods of increasing the damping in structures are now being utilized for important buildings, both new and existing. Improvements in seismic design are continuing to be made such as permitting safe inelastic deformations in the event of very strong ground shaking.
- A problem that the engineer must share with the seismologist/geologist is that of prediction of future occurrence of earthquake, which is not possible in current scenario.
- Earthquake resistant construction requires seismic considerations at all stages; from architectural planning to structural design to actual constructions and quality control.



- Problems pertaining to Earthquake engineering in a seismic country cannot be solved in a short time, so engineers must be prepared to continue working to improve public safety during earthquake. In time, they must control the performance of structures so that effect of earthquake does not create panic in society and its after effects are easily restorable.
- To ensure seismic resistant construction, earthquake engineering knowledge needs to spread to a broad spectrum of professional engineers within the country, rather than confining it to a few organizations or individuals as if it were a super-speciality.

## Terminology for Earthquake Engineering

### 1 Focus or Hypocenter

In an earthquake the waves emanate from a finite area of rocks. However, the point from which the waves first emanate or where the fault movement starts is called the earthquake focus or hypocenter.

### 2 Epicentre

The point on the ground surface just above the focus is called the epicentre.

### 3 Shallow Focus Earthquake

Shallow focus earthquake occurs where the focus is less than 70 km deep from ground surface.

### 4 Intermediate Focus Earthquake

Intermediate focus earthquake occurs where the focus is between 70 km to 300 km deep.

### 5 Deep Focus Earthquake

Deep focus earthquake occurs where the depth of focus is more than 300 km.

### 6 Epicentre Distance

Distance between epicentre and recording station in km or in degrees is called epicentre distance.

### 7 Foreshocks

Fore shocks are smaller earthquakes that precede the main earthquake.

### 8 Aftershocks

Aftershocks are smaller earthquakes that follow the main earthquake.

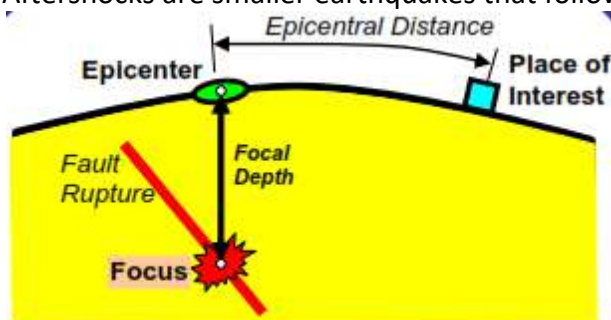

### 9 Magnitude

The magnitude of earthquake is a number, which is a measure of energy released in an earthquake. It is defined as logarithm to the base 10 of the maximum trace amplitude, expressed in microns, which the standard short-period torsion seismometer (with a period of

0.8s, magnification 2800 and damping nearly critical) would register due to the earthquake at an epicentral distance of 100 km.

### **10 Intensity**

The intensity of an earthquake at a place is a measure of the strength of shaking during the earthquake, and is indicated by a number according to the modified Mercalli Scale or M.S.K. Scale of seismic intensities.

### **11 Basic difference between Magnitude and Intensity**

Magnitude of an earthquake is a measure of its size, whereas intensity is an indicator of the severity of shaking generated at a given location. Clearly, the severity of shaking is much higher near the epicenter than farther away.

This can be elaborated by considering the analogy of an electric bulb. Here, the size of the bulb (100-Watt) is like the magnitude of an earthquake (M), and the illumination (measured in lumens) at a location like the intensity of shaking at that location

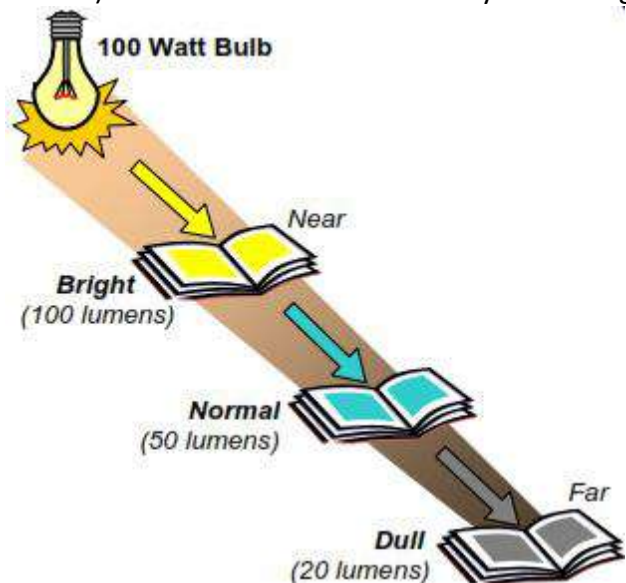

**Fig-Reducing illumination with distance from an electric bulb.**

### **12 Liquefaction**

Liquefaction is a state in saturated cohesion-less soil wherein the effective shear strength is reduced to negligible value for all engineering purpose due to pore pressure caused by vibrations during an earthquake when they approach the total confining pressure. In this condition, the soil tends to behave like a fluid mass.

### **13 Tectonic Feature**

The nature of geological formation of the bedrock in the earth's crust revealing regions characterized by structural features, such as dislocation, distortion, faults, folding, thrusts, volcanoes with their age of formation, which are directly involved in the earth movement or quake resulting in the above consequences.

### **14 Seismic Mass**

It is the seismic weight divided by acceleration due to gravity.

### **15 Seismic Weight**

It is the total dead load plus appropriate amounts of specified imposed load.

### **16 Base**

It is the level at which inertia forces generated in the structure are transferred to the foundation, which then transfers these forces to the ground.

### **17 Centre of Mass**

The point, through which the resultant of the masses of a system acts, is called Centre of Mass. This point corresponds to the centre of gravity of masses of system.

### **18 Centre of Stiffness**

The point, through which the resultant of the restoring forces of a system acts, is called Centre of stiffness.

### **19 Box System**

Box is a bearing wall structure without a space frame, where the horizontal forces are resisted by the walls acting as shear walls.

### **20 Band**

A reinforced concrete, reinforced brick or wooden runner provided horizontally in the walls to tie them together, and to impart horizontal bending strength in them.

### **21 Ductility**

Ductility of a structure, or its members, is the capacity to undergo large inelastic deformations without significant loss of strength or stiffness.

### **22 Shear Wall**

Shear wall is a wall that is primarily designed to resist lateral forces in its own plane.

### **23 Ductile Detailing**

Ductile Detailing is the preferred choice of location and amount of reinforcement in reinforced concrete structures to provide adequate ductility. In steel structures, it is the design of members and their connections to make them adequate ductile.

### **24 Elastic Seismic Acceleration Co-Efficient $A$**

This is the horizontal acceleration value, as a fraction of acceleration due to gravity, versus natural period of vibration  $T$  that shall be used in design of structures.

### **25 Natural Period $T$**

Natural period of a structure is its time period of undamped vibration.

a) Fundamental Natural Period  $T_1$ : It is the highest modal time period of vibration along the considered direction of earthquake motion.

b) Modal Natural Period  $T_k$ : Modal natural period of mode  $k$  is the time period of vibration in mode  $k$ .

### **26 Normal Mode**

Mode of vibration at which all the masses in a structure attain maximum values of displacements and rotations, and also pass through equilibrium positions simultaneously.

### **27 Overstrength**

Strength considering all factors that may cause its increase e.g., steel strength being higher than the specified characteristic strength, effect of strain hardening in steel with large strains, and concrete strength being higher than specified characteristic value.

### **28 Response Reduction Factor $R$**

The factor by which the actual lateral force that would be generated, if the structure were to remain elastic during the most severe shaking that is likely at that site, shall be reduced to obtain the design lateral force.

## **29 Response Spectrum**

The representation of the maximum response of idealized single degree freedom system having certain period and damping, during that earthquake. The maximum response is plotted against the undamped natural period and for various damping values, and can be expressed in terms of maximum absolute acceleration, maximum relative velocity or maximum relative displacement.

## **30 Soil Profile Factor S**

A factor used to obtain the elastic acceleration spectrum depending on the soil profile below the foundation of structure.

## **About Earthquake**

### **Earthquake**

- Vibrations of earth's surface caused by waves coming from a source of disturbance inside the earth are described as earthquakes.
- Earthquake is a natural phenomenon occurring with all uncertainties.
- During the earthquake, ground motions occur in a random fashion, both horizontally and vertically, in all directions radiating from epicentre.
- These cause structures to vibrate and induce inertia forces on them.

### **What causes Earthquake**

Earthquakes may be caused by

- Tectonic activity
- Volcanic activity
- Land-slides and rock-falls
- Rock bursting in a mine
- Nuclear explosions

### **Tectonic Activity**

Tectonic activity pertains to geological formation of the bedrock in the earth's crust characterized by structural features, such as dislocation, distortion, faults, folding, thrusts, volcanoes directly involved in the earth movement.

As engineers we are interested in earthquakes that are large enough and close enough (to the structure) to cause concern for structural safety- usually caused by tectonic activity.

Earth consists of following segments –

solid inner core (radius ~1290km) that consists of heavy metals (e.g., nickel and iron)

liquid outer core(thickness ~2200km)

stiffer mantle(thickness ~2900km) that has ability to flow and

crust(thickness ~5 to 40km) that consists of light materials (e.g., basalts and granites)

At the Core, the temperature is estimated to be  $\sim 2500^{\circ}\text{C}$ , the pressure  $\sim 4$  million *atmospheres* and density  $\sim 13.5$  *gm/cc*; this is in contrast to  $\sim 25^{\circ}\text{C}$ , 1 *atmosphere* and 1.5 *gm/cc* on the surface of the Earth.

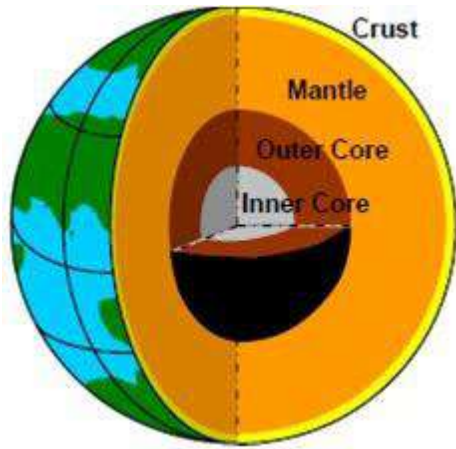
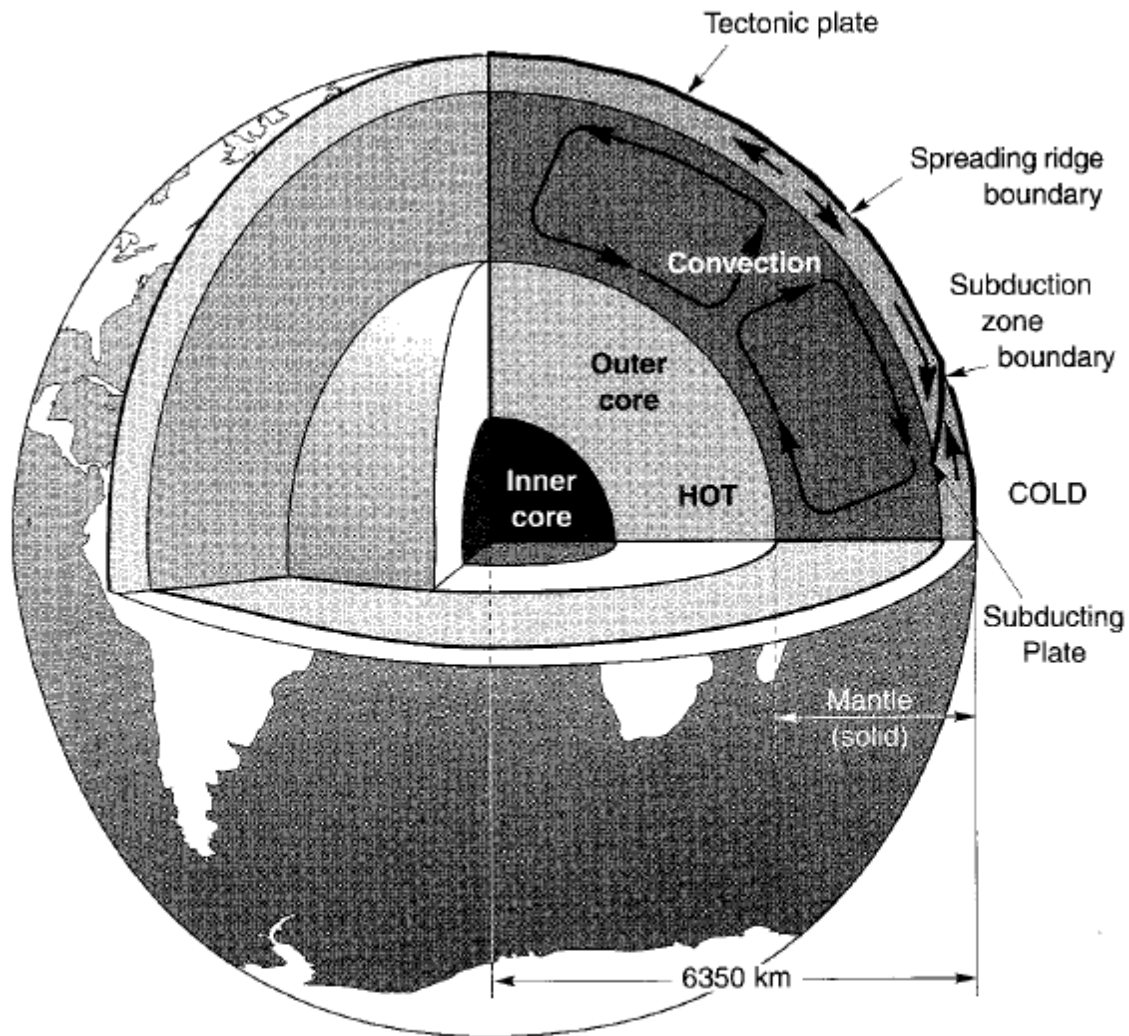

Fig- Inside the earth

Due to prevailing high temperature and pressure gradients between the Crust and the Core, the local convective currents in mantle are developed. These convection currents result in a *circulation* of the earth's mass; hot molten lava comes out and the cold rock mass goes into the Earth. The mass absorbed eventually melts under high temperature and pressure and becomes a part of the Mantle, only to come out again from another location.

Near the bottom of the crust, horizontal component currents impose shear stresses on bottom of crust, causing movement of plates on earth's surface. The movement causes the plates to move apart in some places and to converge in others.

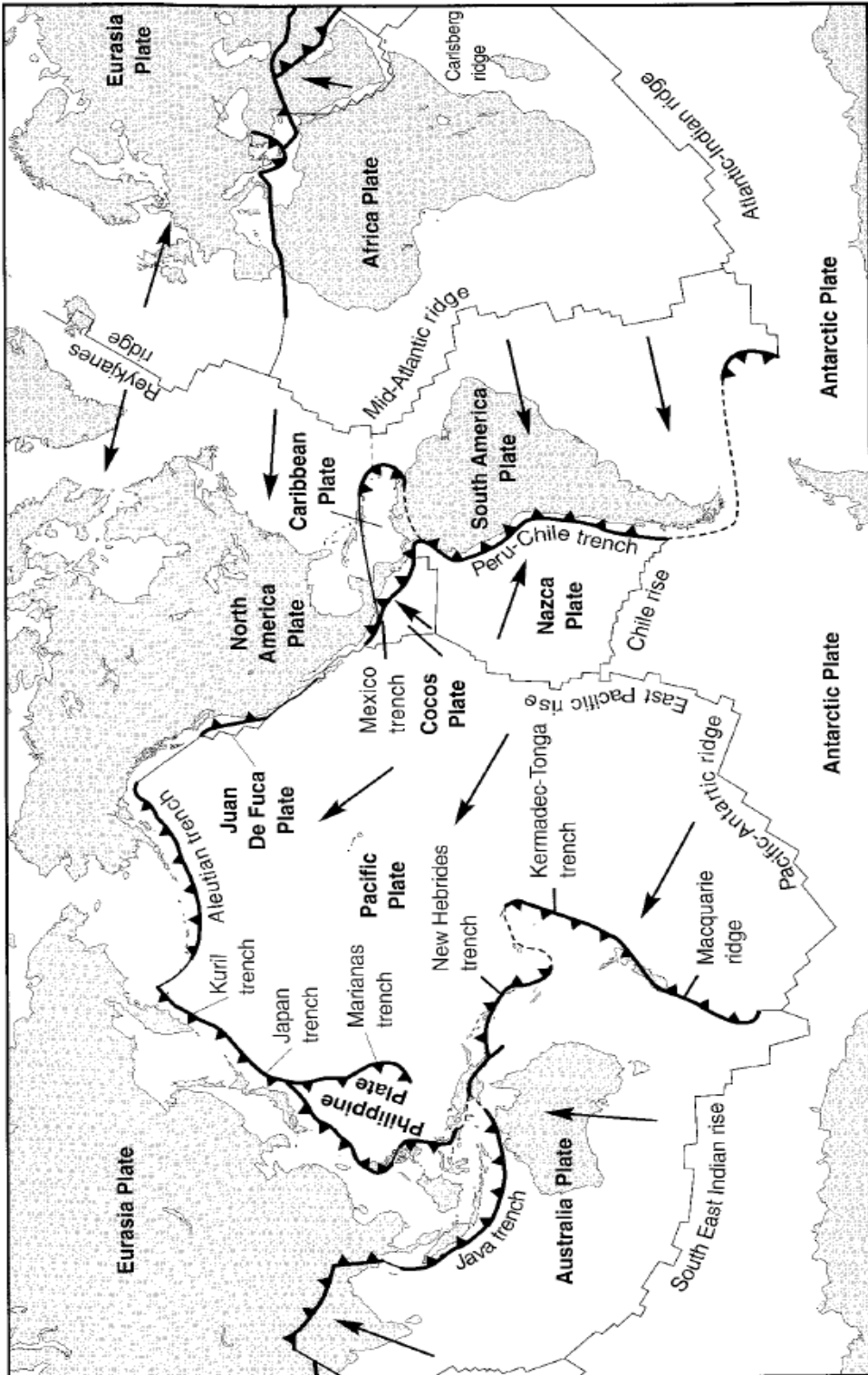

**Figure 2.11** Convection currents in mantle. Near the bottom of the crust, horizontal component of convection currents impose shear stresses on bottom of crust, causing movement of plates on earth's surface. The movement causes the plates to move apart in some places and to converge in others. (After Noson et al., 1988.)

### Theory of Plate Tectonics

**Tectonic Plates:** Basic hypothesis of plate tectonics is that the earth's surface consists of a number of large, intact blocks called *plates* or *tectonic plates* and these plates move with respect to each other due to the convective flows of Mantle material, which causes the Crust and some portion of the Mantle, to slide on the hot molten outer core. The major plates are shown in Fig.

The earth's crust is divided into six continental-sized plates (African, American, Antarctic, Australia-Indian, Eurasian, and Pacific) and about 14 of sub-continental size (e.g., Carribean, Cocos, Nazca, Philippine, etc.). Smaller *platelets* or *micro-plates* also have broken off from the larger plates in the vicinity of many of the major plate boundaries.



**Figure 2.9** The major tectonic plates, mid-oceanic ridges, trenches, and transform faults of the earth. Arrows indicate directions of plate movement. (After Fowler, 1990.)

**Fig** The major tectonic plates, mid-oceanic ridges, trenches and transform faults of the earth. Arrows indicate the directions of plate movement.

The relative deformation between plates occurs only in narrow zones near their boundaries. These deformations are:

1. *Aseismic deformation*: This deformation of the plates occurs slowly and continuously.
2. *Seismic deformation*: This deformation occurs with sudden outburst of energy in the form of earthquakes.

The boundaries are: (i) Convergent (ii) Divergent (iii) Transform

**Convergent boundary:** Sometimes, the plate in the front is slower. Then, the plate behind it comes and collides (and *mountains* are formed). This type of inter-plate interaction is the *convergent boundary*

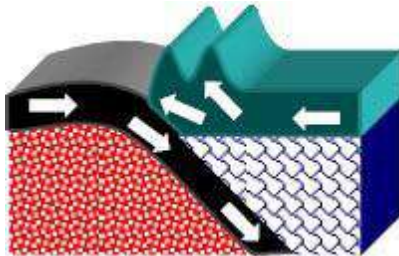

Fig- Convergent boundary

**Divergent boundary:** Sometimes, two plates move away from one another (and *rifts* are created). This type of inter-plate interaction is the *divergent boundary*

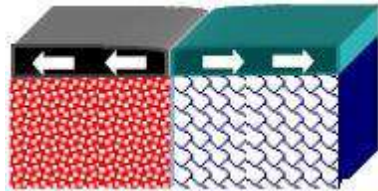

Fig- Divergent boundary

**Transform boundary:** Sometimes, two plates move side-by-side, along the same direction or in opposite directions. This type of inter-plate interaction is the *transform boundary*.

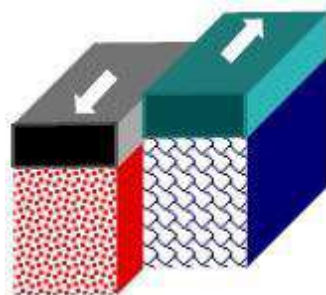
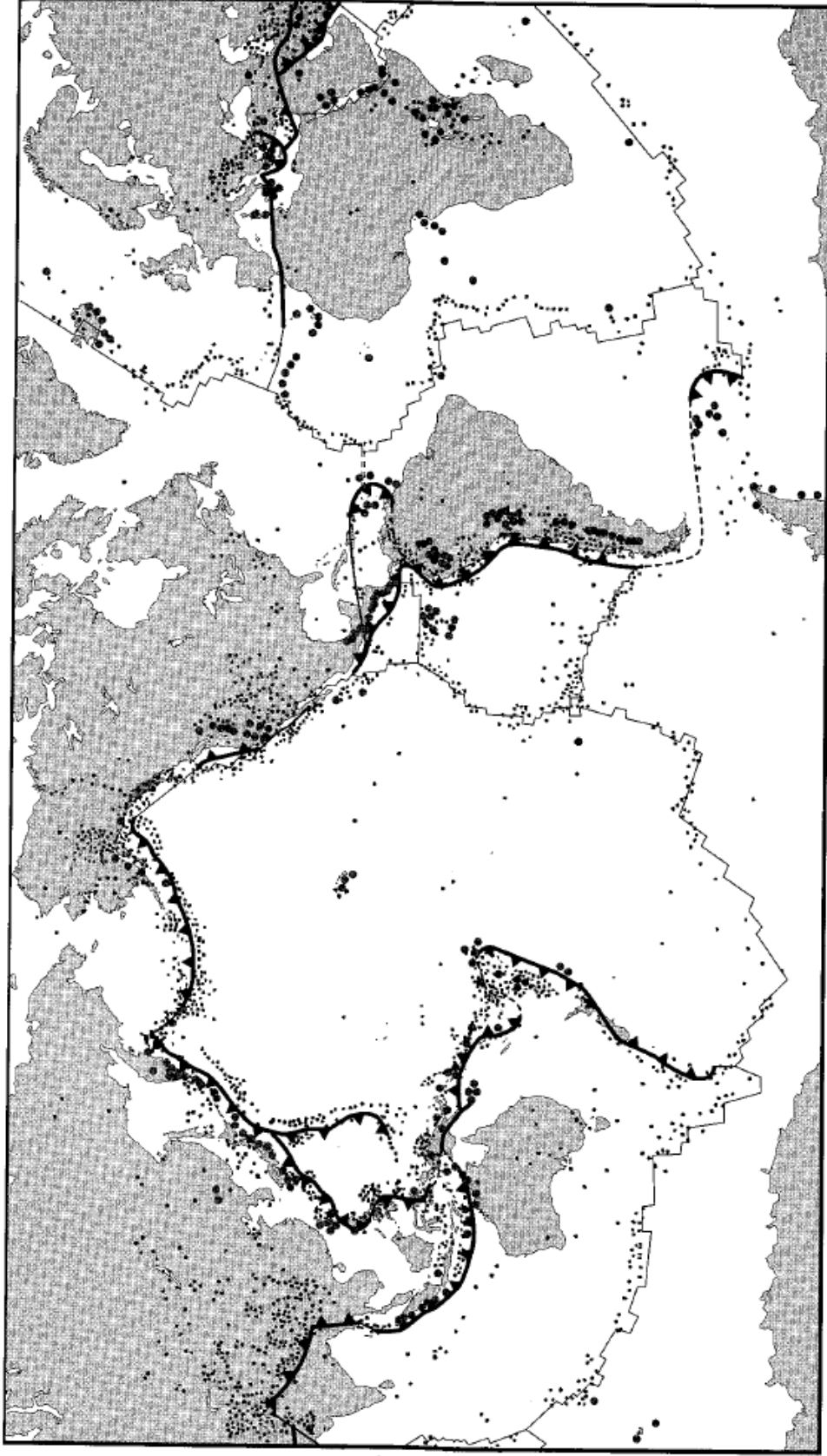

Fig-Transform Boundary

Since the deformation occurs predominantly at the boundaries between the plates, it would be expected that the locations of earthquakes would be concentrated near plate boundaries. The map of earthquake epicentres shown in figure provides strong support to confirm the theory of plate tectonics. The dots represent the epicentres of significant earthquakes. It is apparent that the locations of the great majority of earthquakes correspond to the boundaries between plates.





**Figure 2.10** Worldwide seismic activity. The dots represent the epicenters of significant earthquakes. It is apparent that the locations of the great majority of earthquakes correspond to the boundaries between plates. (After Bolt, 1988.)

### Elastic Rebound Theory

Earth crust for some reason is moving in opposite directions on certain faults. This sets up elastic strains in the rocks in the region near this fault. As the motion goes on, the stresses build up in the rocks until the stresses are large enough to cause slip between the two adjoining portions of rocks on either side. A rupture takes place and the strained rock rebounds back due to internal stress. Thus the strain energy in the rock is relieved partly or fully (Fig. 3.8).

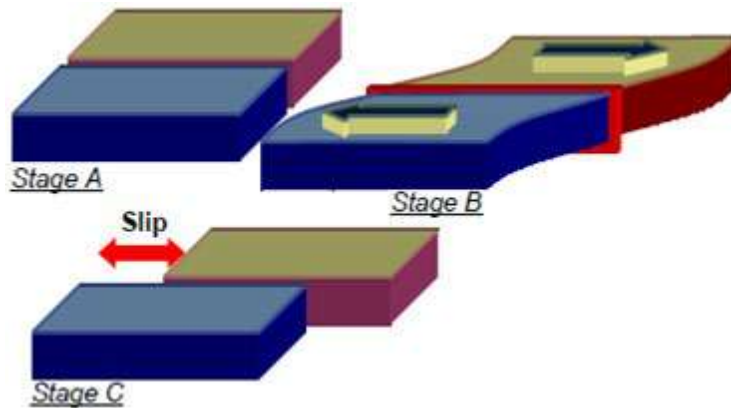

Fig- Elastic Strain Build-Up and Brittle Rupture

**Fault:** The interface between the plates where the movement has taken place is called fault.

**Slip:** When the rocky material along the interface of the plates in the Earth's Crust reaches its strength, it fractures and a sudden movement called slip takes place.

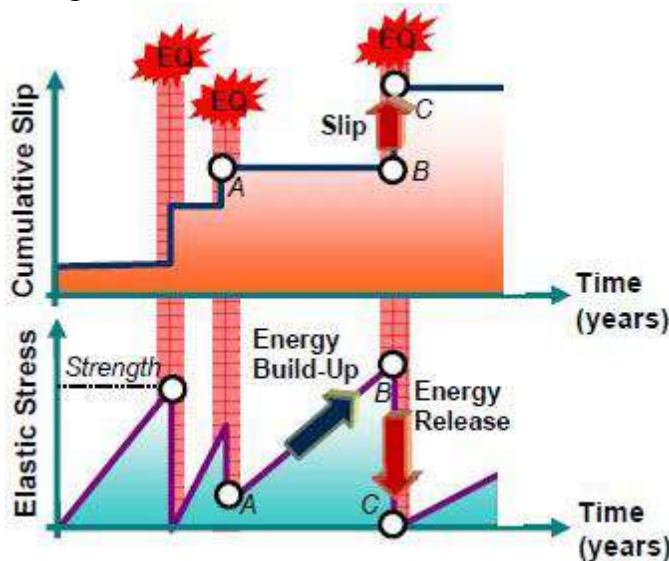

Fig- Elastic Rebound Theory

**The sudden slip at the fault causes the earthquake.** A violent shaking of the Earth during which large elastic strain energy released spreads out in the form of seismic waves that travel through the body and along the surface of the Earth.

After elastic rebound there is a readjustment and reapportion of the remaining strains in the region. The stress grows on a section of fault until slip occurs again; this causes yet another even though smaller earthquake which is termed as *aftershock*. The aftershock activity continues until the stresses are below the threshold level everywhere in the rock.

After the earthquake is over, the process of strain build-up at this modified interface between the tectonic plates starts all over again. This is known as the *Elastic Rebound Theory* (Fig. 3.9).

### Types of Earthquakes and Faults

**Inter-plate Earthquakes:** Most earthquakes occurring along the boundaries of the tectonic plates are called Inter-plate Earthquakes, (e.g., 1897 Assam (India) earthquake).

**Intra-plate Earthquakes:** Numbers of earthquakes occurring within the plate itself but away from the plate boundaries are called Intra-plate Earthquakes, (e.g., 1993 Latur (India) earthquake).

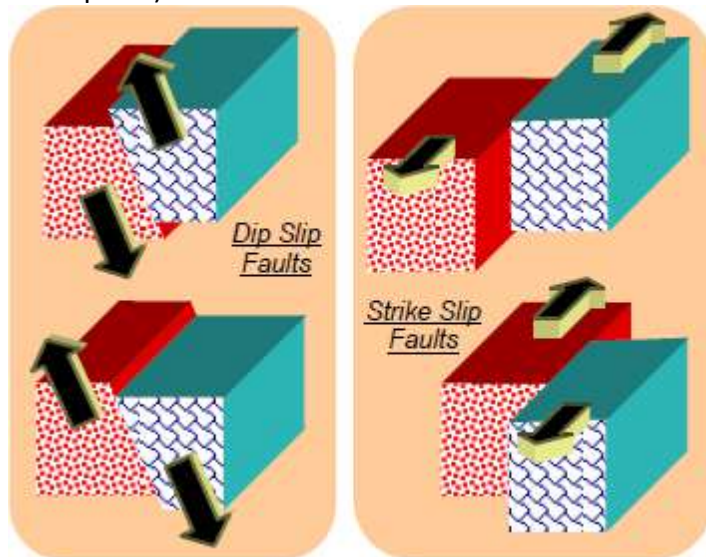
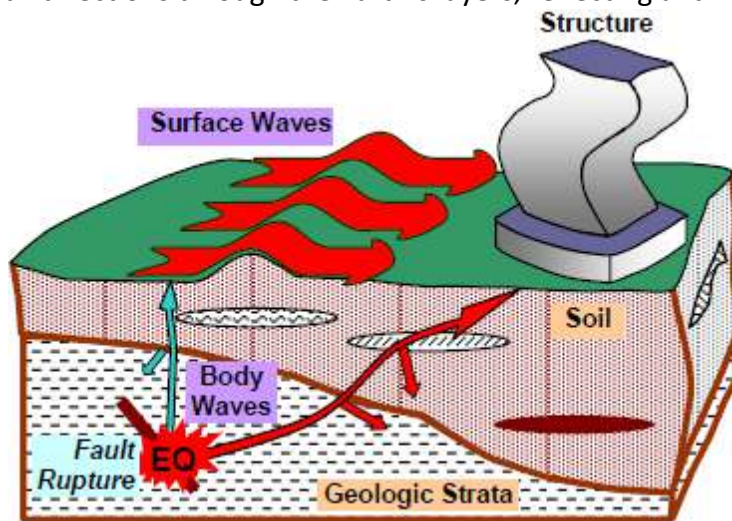

Fig- Types of fault

**Note:** In both types of earthquakes, the slip generated at the fault during earthquakes is along both vertical and horizontal directions (called Dip Slip) and lateral directions (called Strike Slip), with one of them dominating sometimes (Fig. 3.10).

### How the Ground shakes

**Seismic waves:** Large strain energy released during an earthquake travels as seismic waves in all directions through the Earth's layers, reflecting and refracting at each interface .



There are of two types of waves: 1) Body Waves 2) Surface Waves

Body waves are of two types:

- a) Primary Waves (P-Wave)
- b) Secondary Wave (S-Wave)

Surface waves are of two types, namely

- a) Love Waves
- b) Rayleigh Waves

**Body Waves:** Body waves have spherical wave front. They consist of:

**Primary Waves (P-waves):** Under P-waves, material particles undergo extensional and compressional strains along direction of energy transmission. These waves are faster than all other types of waves.

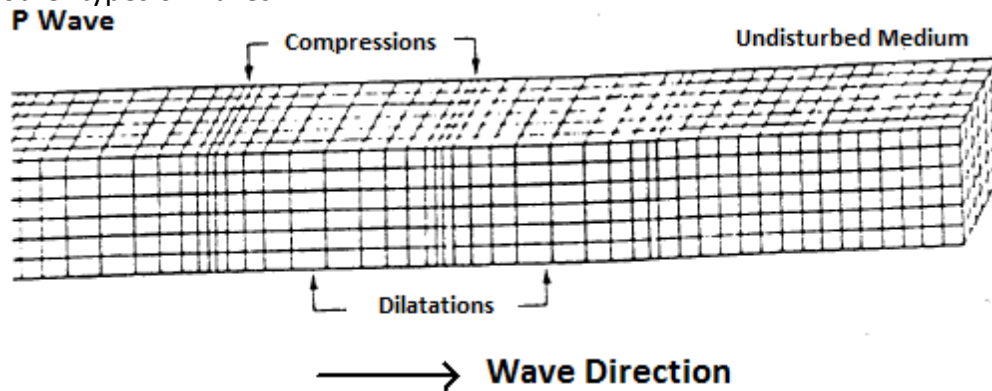

**Secondary Waves (S-waves):** Under S-waves, material particles oscillate at

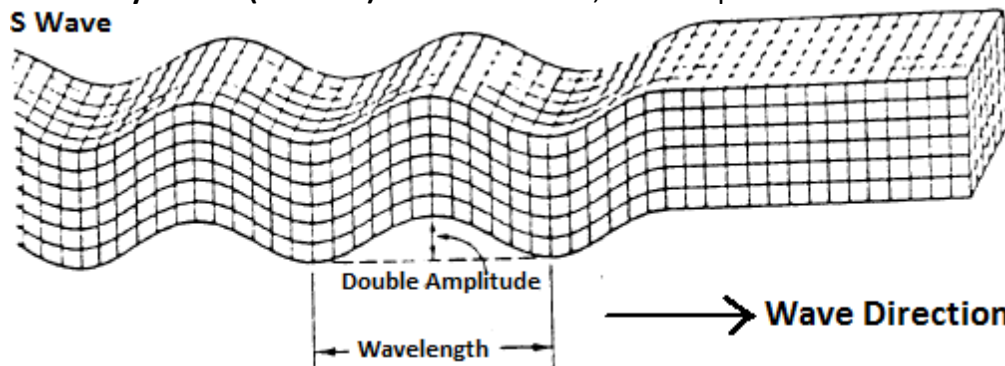

right angles to direction of energy transmission. This type of wave shears the rock particle to the direction of wave travel. Since the liquid has no shearing resistance, these waves cannot pass through liquids.

**Surface Waves:** Surface waves have cylindrical wave front. They consist of:

**Love Waves:** In case of Love waves, the displacement is transverse with no vertical or longitudinal components (i.e. similar to secondary waves with no vertical component). Particle motion is restricted to near the surface. Love waves being transverse waves, these cannot travel in liquids.

### Love Wave

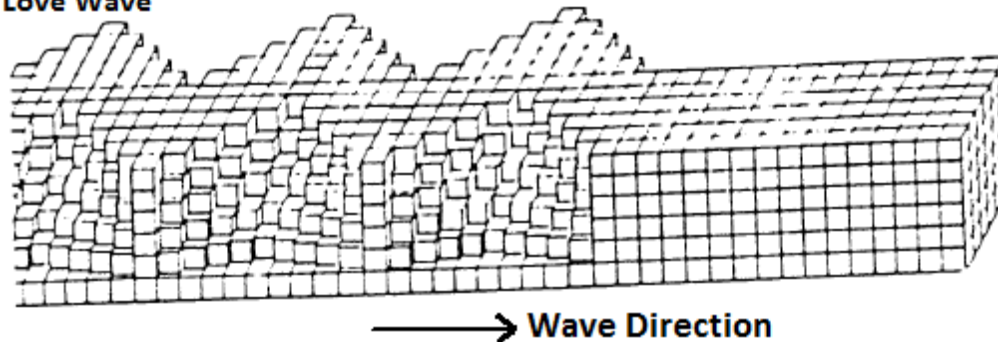

**Rayleigh Waves:** Rayleigh waves make a material particle oscillate in an elliptic path in the vertical plane with horizontal motion along direction of energy transmission.

### Rayleigh Wave

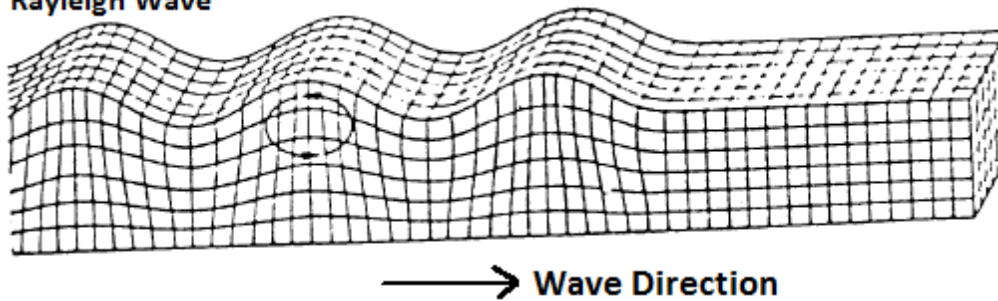

Fig- Motion caused by Rayleigh Wave

**Note:** Primary waves are fastest, followed in sequence by Secondary, Love and Rayleigh waves.

### Effects of Earthquake or Seismic Hazards

Basic causes of earthquake-induced damage are:

- Ground shaking
- Structural hazards
- Liquefaction
- Ground failure/ Landslides
- Tsunamis, and
- Fire

### Ground shaking

- Ground shaking can be considered to be the most important of all seismic hazards because all the other hazards are caused by ground shaking.
- When an earthquake occurs, seismic waves radiate away from the source and travel rapidly through the earth's crust.
- When these waves reach the ground surface, they produce shaking that may last from

seconds to minutes.

- The strength and duration of shaking at a particular site depends on the size and location of the earthquake and on the characteristics of the site.
- At sites near the source of a large earthquake, ground shaking can cause tremendous damage.
- Where ground shaking levels are low, the other seismic hazards may be low or nonexistent
- Strong ground shaking can produce extensive damage from a variety of seismic hazards depending upon the characteristics of the soil.
- The characteristics of the soil can greatly influence the nature of shaking at the ground surface.
- Soil deposits tend to act as “filters” to seismic waves by attenuating motion at certain frequencies and amplifying it at others.
- Since soil conditions often vary dramatically over short distances, levels of ground shaking can vary significantly within a small area.
- One of the most important aspects of geotechnical earthquake engineering practice involves evaluation of the effects of local soil conditions on strong ground motion.

### **Structural Hazards**

- Without doubt the most dramatic and memorable images of earthquake damage are those of structural collapse, which is the leading cause of death and economic loss in many earthquakes.
- As the earth vibrates, all buildings on the ground surface will respond to that vibration in varying degrees.
- Earthquake induced accelerations, velocities and displacements can damage or destroy a building unless it has been designed and constructed or strengthened to be earthquake resistant.
- The effect of ground shaking on buildings is a principal area of consideration in the design of earthquake resistant buildings.
- Seismic design loads are extremely difficult to determine due to the random nature of earthquake motions.
- Structures need not collapse to cause death and damage. Falling objects such as brick facings and parapets on the outside of a structure or heavy pictures and shelves within a structure have caused casualties in many earthquakes. Interior facilities such as piping, lighting, and storage systems can also be damaged during earthquakes.

- However, experiences from past strong earthquakes have shown that reasonable and prudent practices can keep a building safe during an earthquake.
- Over the years, considerable advancement in earthquake-resistant design has moved from an emphasis on structural strength to emphases on both strength and ductility. In current design practice, the geotechnical earthquake engineer is often consulted for providing the structural engineer with appropriate design ground motions.

### **Liquefaction**

In some cases, earthquake damage have occurred when soil deposits have lost their strength and appeared to flow as fluids. This phenomenon is termed as *liquefaction*. In *liquefaction*, the strength of the soil is reduced, often drastically, to the point where it is unable to support structures or remain stable. Because it only occurs in saturated soils, liquefaction is most commonly observed near rives, bays, and other bodies of water.

Soil liquefaction can occur in low density saturated sands of relatively uniform size. The phenomenon of liquefaction is particularly important for dams, bridges, underground pipelines, and buildings standing on such ground.

### **Ground Failure / Land slides**

- 1) Earthquake-induced ground Failure has been observed in the form of ground rupture along the fault zone, landslides, settlement and soil liquefaction.
- 2) Ground rupture along a fault zone may be very limited or may extend over hundreds of kilometers.
- 3) Ground displacement along the fault may be horizontal, vertical or both, and can be measured in centimetres or even metres.
- 4) A building directly astride such a rupture will be severely damaged or collapsed.
- 5) Strong earthquakes often cause landslides.
- 6) In a number of unfortunate cases, earthquake-induced landslides have buried entire towns and villages.
- 7) Earthquake-induced landslides cause damage by destroying buildings, or disrupting bridges and other constructed facilities.
- 8) Many earthquake-induced landslides result from liquefaction phenomenon.
- 9) Others landslides simply represent the failures of slopes that were marginally stable under static conditions.
- 10) Landslide can destroy a building; the settlement may only damage the building.

### **Tsunamis**

- 1) Tsunamis or seismic sea waves are generally produced by a sudden movement of the ocean floor.
- 2) Rapid vertical seafloor movements caused by fault rupture during earthquakes can produce long-period sea waves i.e. *Tsunamis*.
- 3) In the open sea, tsunamis travel great distances at high speeds but are difficult to detect – they usually have heights of less than 1 m and wavelengths (the distance between crests) of several hundred kilometres.

4) As a tsunami approaches shore, the decreasing water depth causes its speed to decrease and the height of the wave to increase.

5) As the water waves approach land, their velocity decreases and their height increases from 5 to 8 m, or even more.

6) In some coastal areas, the shape of the seafloor may amplify the wave, producing a nearly vertical wall of water that rushes far inland and causes devastating damage.

7) Tsunamis can be devastating for buildings built in coastal areas.

### **Fire**

When the fire following an earthquake starts, it becomes difficult to extinguish it, since a strong earthquake is accompanied by the loss of water supply and traffic jams. Therefore, the earthquake damage increases with the earthquake-induced fire in addition to the damage to buildings directly due to earthquakes.

### **Seismic Zone and Measurement of Earthquake**

#### **Seismic Zone**

Due to convective flow of mantle material, crust of Earth and some portion of mantle slide on hot molten outer core. This sliding of Earth's mass takes place in pieces called Tectonic Plates. The surface of the Earth consists of seven major tectonic plates .

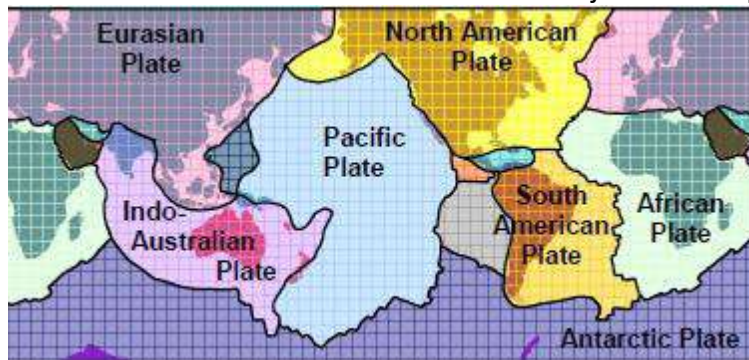

Fig- Major Tectonic Plates on the Earth's surface

They are

1. Eurasian Plate
2. Indo-Australian Plate
3. Pacific Plate
4. North American Plate
5. South American Plate
6. African Plate
7. Antarctic Plate

India lies at the northwestern end of the Indo Australian Plate . This Plate is colliding against the huge Eurasian Plate and going under the Eurasian Plate. Three chief tectonic sub-regions of India are

- the mighty Himalayas along the north,



- the plains of the Ganges and other rivers, and
- the peninsula

Most earthquakes occur along the Himalayan plate boundary (these are inter-plate earthquakes), but a number of earthquakes have also occurred in the peninsular region (these are intra-plate earthquakes).

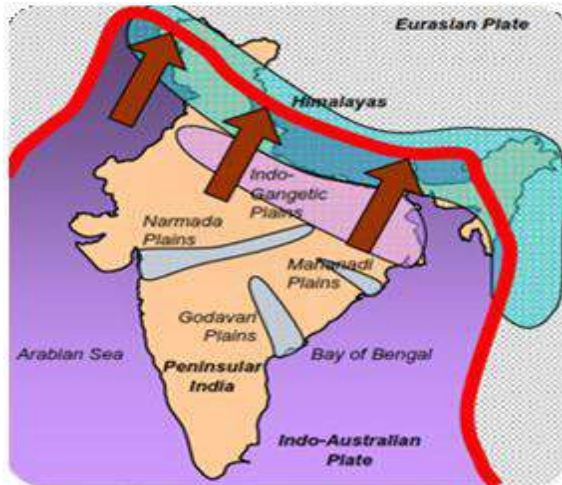

Fig- Geographical Layout and tectonic boundary in India

Bureau of Indian Standards [IS1893 (part – 1) : 2002], based on various scientific inputs from a number of agencies including earthquake data supplied by Indian Meteorological Department (IMD), has grouped the country into four seismic zones viz., Zone II, III, IV and V. Of these, Zone V is rated as the most seismically prone region, while Zone II is the least

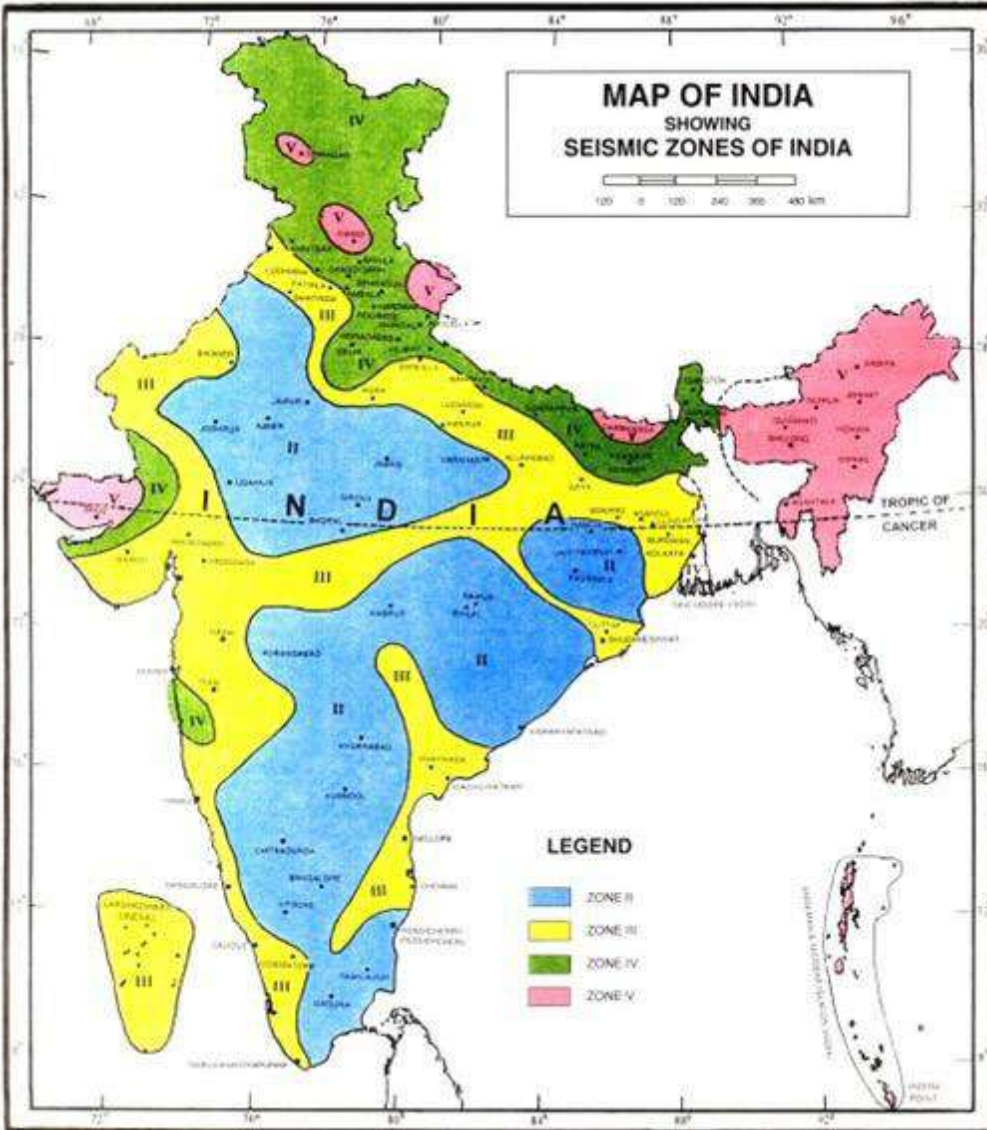

Fig- Map showing Seismic Zones of India [IS 1893 (Part 1): 2002]

Indian Seismic code (IS 1893:2002) divides the country into four seismic zones based on the expected intensity of shaking in future earthquake. The four zones correspond to areas that have potential for shaking intensity on MSK scale as shown in the table.

Seismic Zone	Intensity on MSK scale	% of total area
II (Low intensity zone)	VI (or less)	43%
III (Moderate intensity zone)	VII	27%
IV (Severe intensity zone)	VIII	18%
V (Very Severe intensity zone)	IX (and above)	12%

### Measurement of Earthquake

#### Measuring Instruments

**Seismograph:** The instrument that measures earthquake shaking is known as a seismograph. It has three components –

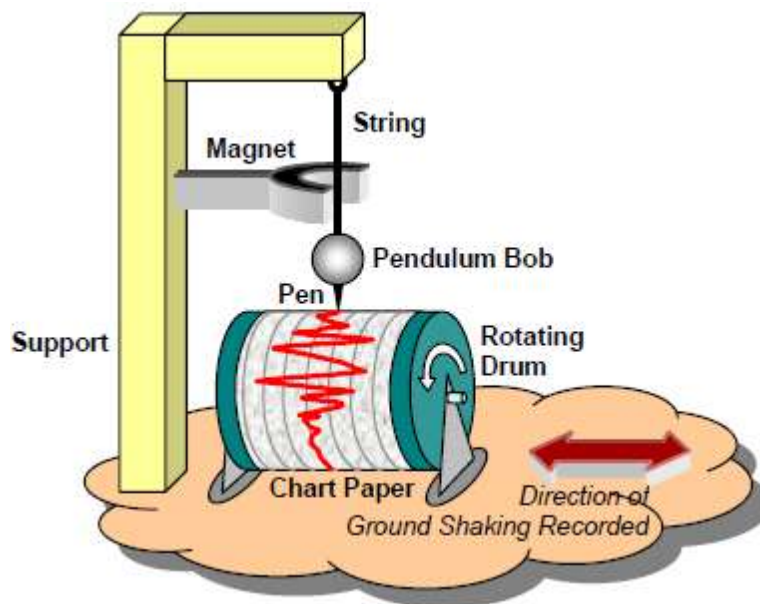

Fig- Schematic of Seismograph

**Sensor** – It consists of pendulum mass, string, magnet and support.

**Recorder** – It consists of drum, pen and chart paper.

**Timer** – It consists of the motor that rotates the drum at constant speed.

**Seismoscopes:** Some instruments that do not have a timer device provide only the maximum extent (or scope) of motion during the earthquake.

**Digital instruments:** The digital instruments using modern computer technology records the ground motion on the memory of the microprocessor that is in-built in the instrument.

**Note:** *The analogue instruments have evolved over time, but today, digital instruments are more commonly used.*

#### Scale of Measurement

The Richter Magnitude Scale (also called Richter scale) assigns a magnitude number to quantify the energy released by an earthquake. Richter scale is a base 10 logarithmic scale, which defines magnitude as the logarithm of the ratio of the amplitude of the seismic wave to an arbitrary minor amplitude.

The magnitude  $M$  of an Earthquake is defined as

$$M = \log_{10} A - \log_{10} A_0$$

Where,

$A$  = Recorded trace amplitude for that earthquake at a given distance as written by a standard type of instrument (say Wood Anderson instrument).

$A_0$  = Same as  $A$ , but for a particular earthquake selected as standard.

This number  $M$  is thus independent of distance between the epicentre and the station and is a characteristic of the earthquake. The standard shock has been defined such that it is low enough to make the magnitude of most of the recorded earthquakes positive and is assigned a magnitude of zero. Thus, if  $A = A_0$ ,

$$M = \log_{10} A_0 - \log_{10} A_0 = 0$$

**Standard shock of magnitude zero:** It is defined as one that records peak amplitude of one thousandths of a millimetre at a distance of 100 km from the epicentre.

- 1) Zero magnitude does not mean that there is no earthquake.
- 2) Magnitude of an earthquake can be a negative number also.
- 3) An earthquake that records peak amplitude of 1 mm on a standard seismograph at 100 km will have its magnitude as

$$M = \log_{10} (1) - \log_{10} (10^{-3}) = 0 - (-3) = 3$$

**Magnitude of a local earthquake:** It is defined as the logarithm to base 10 of the maximum seismic wave amplitude (in thousandths of a mm) recorded on Wood Anderson seismograph at a distance of 100 kms from the earthquake epicentre.

#### **Types of Earthquake Magnitude Scales**

Several scales have historically been described as the "Richter Scale". The Richter local magnitude ( $M_L$ ) is the best known magnitude scale, but it is not always the most appropriate scale for description of earthquake size. The Richter local magnitude does not distinguish between different types of waves.

At large epicentral distances, body waves have usually been attenuated and scattered sufficiently that the resulting motion is dominated by surface waves.

Other magnitude scales that base the magnitude on the amplitude of a particular wave have been developed. They are:

a) Surface Wave Magnitude ( $M_S$ )

b) Body Wave Magnitude ( $M_b$ )

c) Moment Magnitude ( $M_w$ )

#### **General Principle for improving Earthquake Resistance in Building**

##### **Lightness**

Since the earthquake force is a function of mass, the building should be as light as possible consistent with structural safety and functional requirements. Roofs and upper storeys of buildings in particular should be designed as light as possible.

#### **Continuity of Construction**

- As far as possible, all parts of the building should be tied together in such a manner that the building acts as one unit.
- For integral action of building, roof and floor slabs should be continuous throughout as far as possible.
- Additions and alterations to the structures should be accompanied by the provision of positive measures to establish continuity between the existing and the new construction.

#### **Projecting and Suspended Parts**

- Projecting parts should be avoided as far as possible. If the projecting parts cannot be avoided, they should be properly reinforced and firmly tied to the main structure.
- Ceiling plaster should preferably be avoided. When it is unavoidable, the plaster should be as thin as possible.
- Suspended ceiling should be avoided as far as possible. Where provided, they should be light and adequately framed and secured.

#### **Shape of Building**

- In order to minimize torsion and stress concentration, the building should have a simple rectangular plan.
- It should be symmetrical both with respect to mass and rigidity so that the centre of mass and rigidity of the building coincide with each other.
- It will be desirable to use separate blocks of rectangular shape particularly in seismic zones V and IV.

#### **Preferred Building Layouts**

Buildings having plans with shapes like, L, T, E and Y shall preferably be separated into rectangular parts by providing separation sections at appropriate places. Typical examples are shown in Fig.

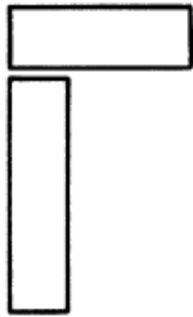

L - SHAPE

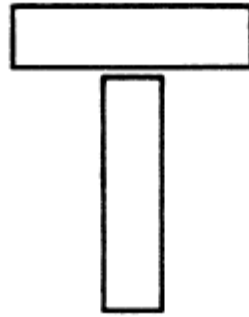

T - SHAPE

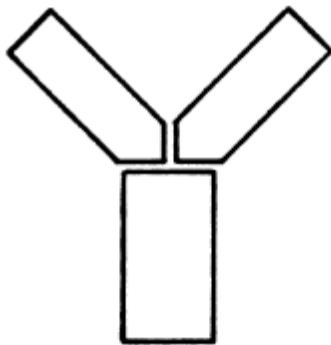

Y - SHAPE

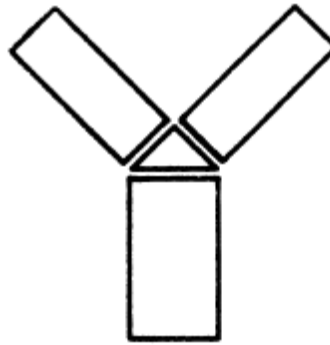

Y - SHAPE

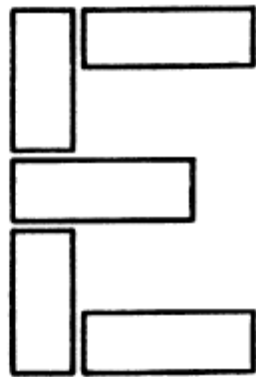

E - SHAPE

. 1 TYPICAL SHAPES OF BUILDING WITH SEPARATION SECTIONS

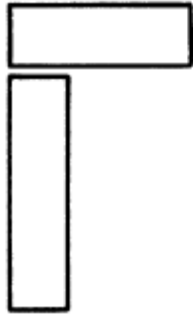

L - SHAPE

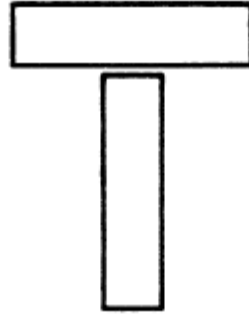

T - SHAPE

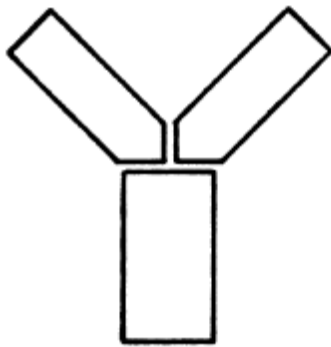

Y - SHAPE

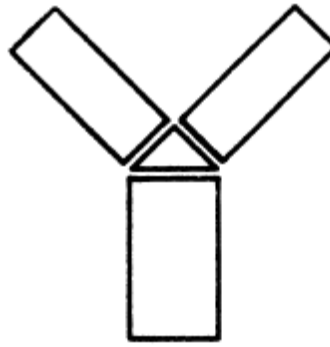

Y - SHAPE

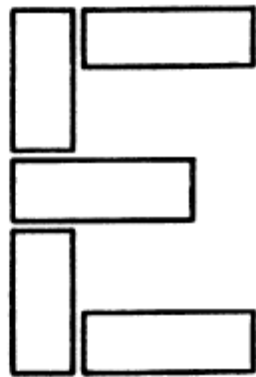

E - SHAPE

#### . 1 TYPICAL SHAPES OF BUILDING WITH SEPARATION SECTIONS

##### **Strength in Various Directions**

The structure shall have adequate strength against earthquake effects along both the horizontal axes considering the reversible nature of earthquake forces.

##### **Foundations**

- For the design of foundations, the provisions of IS 1904: 1986 in conjunction with IS

1893: 1984 shall generally be followed.

- The sub-grade below the entire area of the building shall preferably be of the same type of the soil. Wherever this is not possible, a suitably located separation or crumple section shall be provided.
- Loose fine sand, soft silt and expansive clays should be avoided. If unavoidable, the building shall rest either on a rigid raft foundation or on piles taken to a firm stratum. However, for light constructions the following measures may be taken to improve the soil on which the foundation of the building may rest:

a) Sand piling, and b) Soil stabilization.

Structure shall not be founded on loose soil, which will subside or liquefy during an earthquake resulting in large differential settlement.

## **Roofs and Floors**

### **Flat roof or floor**

Flat roof or floor shall not preferably be made of terrace of ordinary bricks supported on steel, timber or reinforced concrete joists, nor they shall be of a type which in the event of an earthquake is likely to be loosened and parts of all of which may fall. If this type of construction cannot be avoided, the joists should be blocked at ends and bridged at intervals such that their spacing is not altered during an earthquake.

### **Pitched Roofs**

- For pitched roofs, corrugated iron or asbestos sheets should be used in preference to country, Allahabad or Mangalore tiles or other loose roofing units.
- All roofing materials shall be properly tied to the supporting members.
- Heavy roofing materials should generally be avoided.

### **Pent Roofs**

All roof trusses should be supported on and fixed to timber band reinforced concrete band or reinforced brick band. The holding down bolts should have adequate length as required for earthquake and wind forces.

Where a trussed roof adjoins a masonry gable, the ends of the purlins should be carried on and secured to a plate or bearer which should be adequately bolted to timber reinforced concrete or reinforced brick band at the top of gable end masonry.

- At tie level, all the trusses and the gable end should be provided with diagonal braces in plan so as to transmit the lateral shear due to earthquake force to the gable walls acting as shear walls at the ends.

***NOTE – Hipped roof in general have shown better structural behaviour during earthquakes than gable ended roofs.***



### Jack Arches

Jack arched roofs or floors where used should be provided with mild steel ties in all spans along with diagonal braces in plan to ensure diaphragm actions.

### Staircases

- The interconnection of the stairs with the adjacent floors should be appropriately treated by providing sliding joints at the stairs to eliminate their bracing effect on the floors.
- Ladders may be made fixed at one end and freely resting at the other.
- Large stair halls shall preferably be separated from rest of the building by means of separation or crumple section.

Three types of stair construction may be adopted as described below:

#### Separated Staircases

One end of the staircase rests on a wall and the other end is carried by columns and beams which have no connection with the floors. The opening at the vertical joints between the floor and the staircase may be covered either with a tread plate attached to one side of the joint and sliding on the other side, or covered with some appropriate material which could crumple or fracture during an earthquake without causing structural damage.

The supporting members, columns or walls, are isolated from the surrounding floors by means of separation or crumple sections. A typical example is shown in Fig.

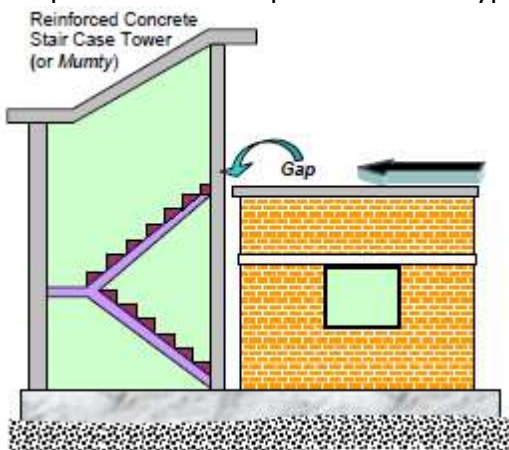

Fig- Separated staircase

#### Built-in Staircase

When stairs are built monolithically with floors, they can be protected against damage by providing rigid walls at the stair opening. An arrangement, in which the staircase is enclosed by two walls, is given in Fig. ). In such cases, the joints, as mentioned in respect of separated staircases, will not be necessary.

The two walls mentioned above, enclosing the staircase, shall extend through the entire height of the stairs and to the building foundations.

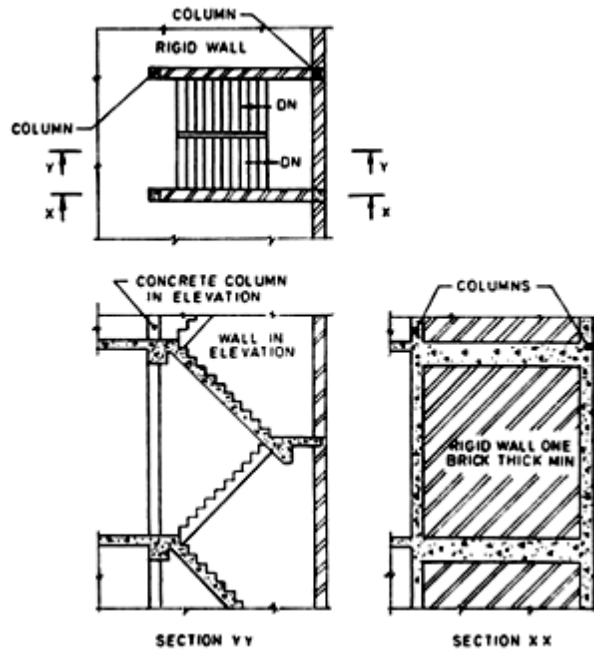

Fig- Rigidly Built-In Staircase [IS 4326: 1993]

### Staircases with Sliding Joints

In case it is not possible to provide rigid walls around stair openings for built-in staircase or to adopt the separated staircases, the staircases shall have sliding joints so that they will not act as diagonal bracing.

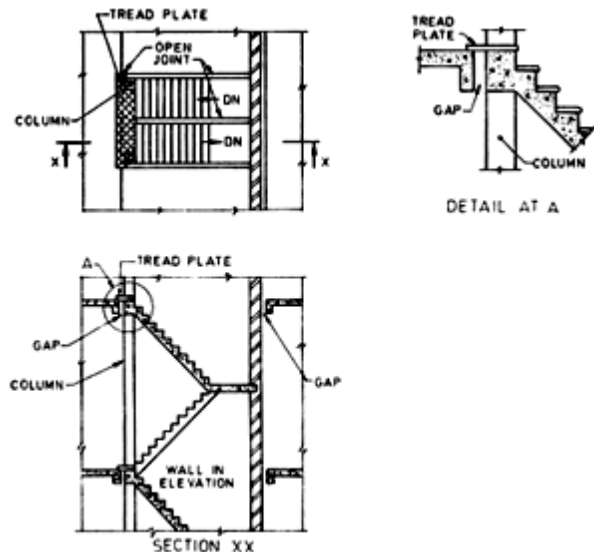

Fig- Staircase with Sliding Joint  
Box Type Construction

This type of construction consists of prefabricated or in-situ masonry wall along with both the axes of the building. The walls support vertical loads and also act as shear walls for horizontal loads acting in any direction. All traditional masonry construction falls under this category. In prefabricated wall construction, attention should be paid to the connections between wall panels so that transfer of shear between them is ensured.

## Fire Safety

Fire frequently follows an earthquake and therefore buildings should be constructed to make them fire resistant in accordance with the provisions of relevant Indian Standards for fire safety. The relevant Indian Standards are IS 1641 : 1988, IS 1642 : 1989, IS 1643 : 1988, IS 1644 : 1988 and IS 1646 : 1986

## Effect of Structural Irregularities on Performance of RC Buildings during Earthquakes

### Effect of Structural Irregularities

There are numerous examples of past earthquakes in which the cause of failure of reinforced concrete building has been ascribed to irregularities in configurations.

Irregularities are mainly categorized as

(i) Horizontal Irregularities

(ii) Vertical Irregularities

### Horizontal Irregularities

Horizontal irregularities refer to asymmetrical plan shapes (e.g. L-, T-, U-, F-) or discontinuities in the horizontal resisting elements (diaphragms) such as cut-outs, large openings, re-entrant corners and other abrupt changes resulting in torsion, diaphragm deformations, stress concentration.

**Table – 6.1 Definitions of Irregular Buildings – Plan Irregularities**

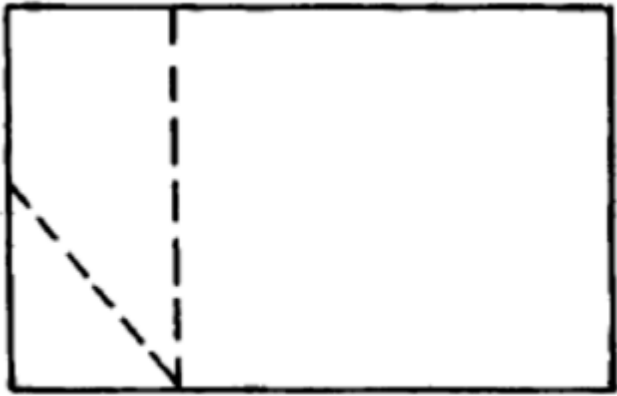
S. No.	Irregularity Type and Description
(i)	<p><b>Torsion Irregularity:</b> To be considered when floor diaphragms are rigid in their own plan in relation to the vertical structural elements that resist the lateral forces. Torsional irregularity to be considered to exist when the maximum storey drift, computed with design eccentricity, at one end of the structures transverse to an axis is more than 1.2 times the average of the storey drifts at the two ends of the structure</p>
(ii)	 <p><b>VERTICAL COMPONENTS OF SEISMIC RESISTING SYSTEM</b></p>

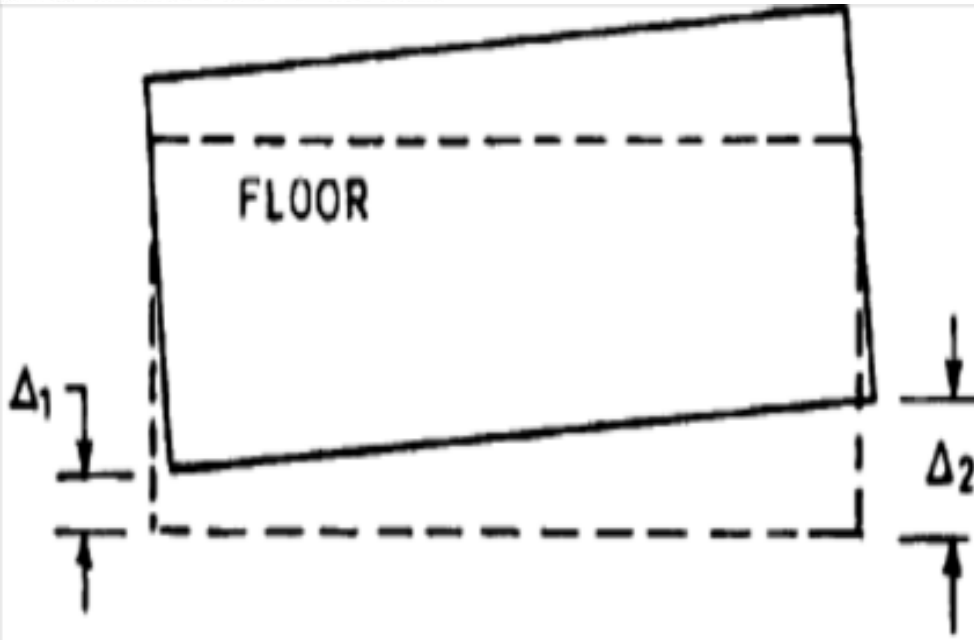
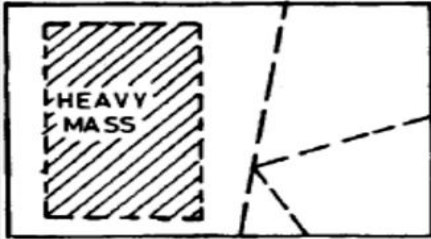

**Re-entrant Corners:** Plan configurations of a structure and its lateral force resisting system contain re-entrant corners, where both projections of the structure beyond the re-entrant corner are greater than 15 percent of its plan dimension in the given direction

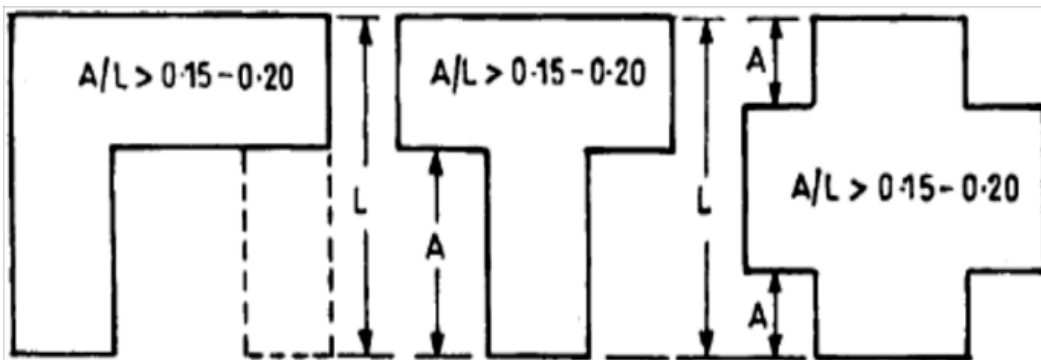

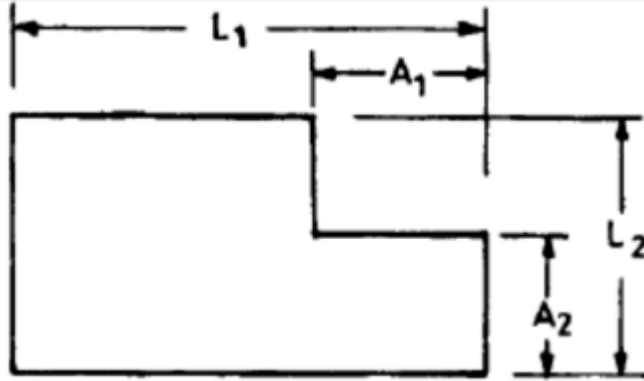

**Diaphragm Discontinuity:** Diaphragms with abrupt discontinuities or variations in stiffness, including those having cut-out or open areas greater than 50 percent of the gross enclosed diaphragm area, or changes in effective diaphragm stiffness of more than 50 percent from one storey to the next

(iii)

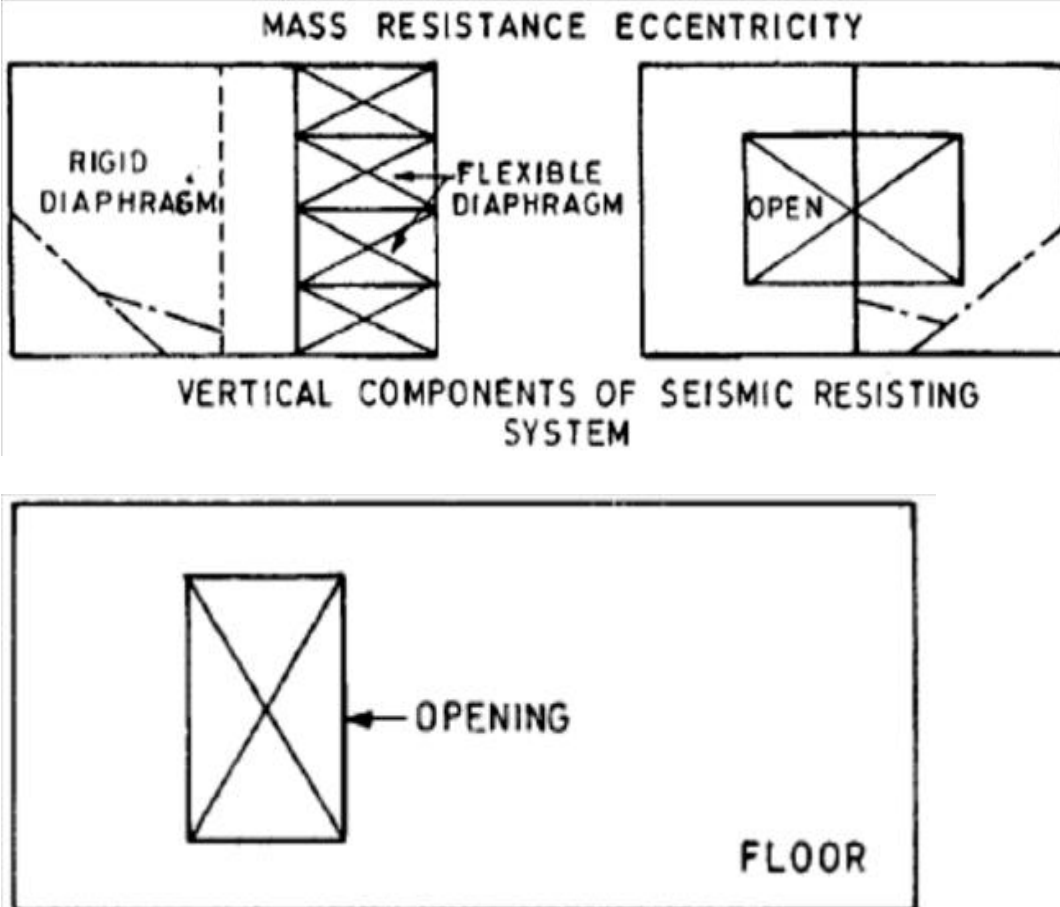

**Out-of-Plane Offsets:** Discontinuities in a lateral force resistance path, such as out-of-plane offsets of vertical elements

(iv)

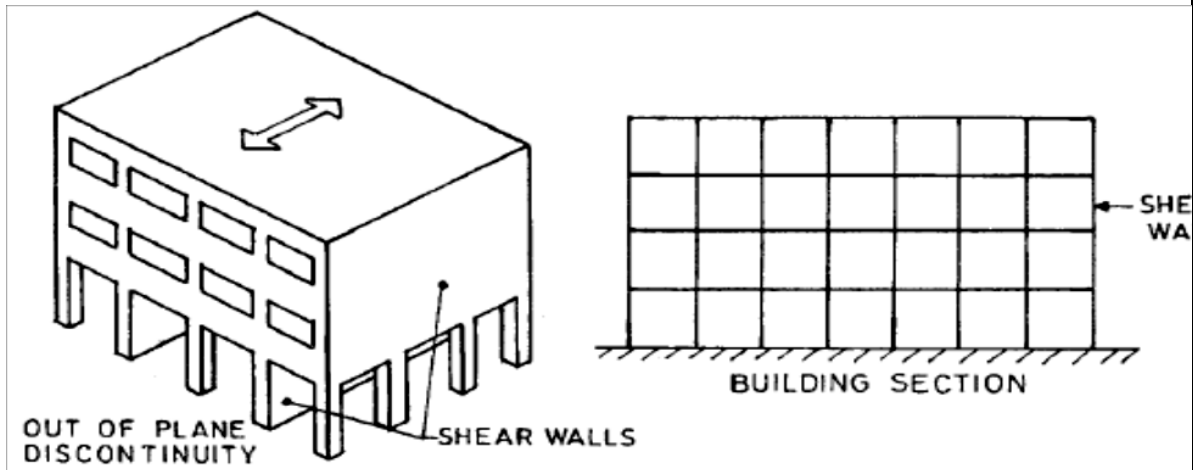

**Non-parallel Systems:** The vertical elements resisting the lateral force are not parallel to or symmetric about the major orthogonal axes or the lateral force resisting elements

(v)

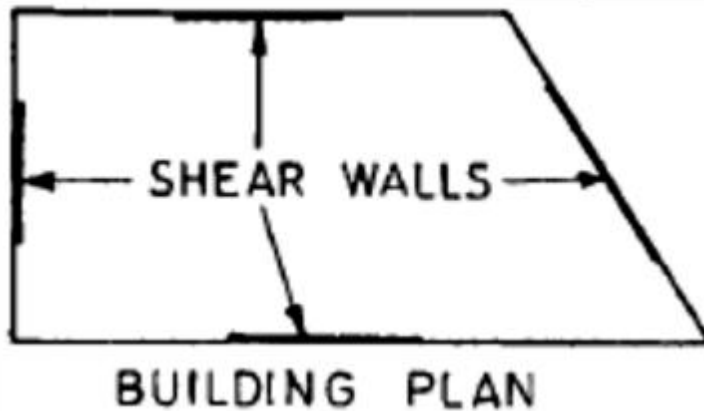

### Vertical Irregularities

Vertical irregularities, referring to sudden change of strength, stiffness, geometry and mass, result in irregular distribution of forces and/ or deformation over the height of building.

**Table – Definition of Irregular Buildings – Vertical Irregularities**

Sl no	Irregularity Type and Description
(i)	<p>a) <b>Stiffness Irregularity – Soft Storey:</b> A soft storey is one in which the lateral stiffness is less than 70 percent of that in the storey above or less than 80 percent of the average lateral stiffness of the three storeys above.</p> <p>b) <b>Stiffness Irregularity – Extreme Soft Storey:</b> A extreme soft storey is one in which the lateral stiffness is less than 60 percent of that in the storey above or less than 70</p>

percent of the average stiffness of the three storeys above. For example, buildings on STILTS will fall under this category.

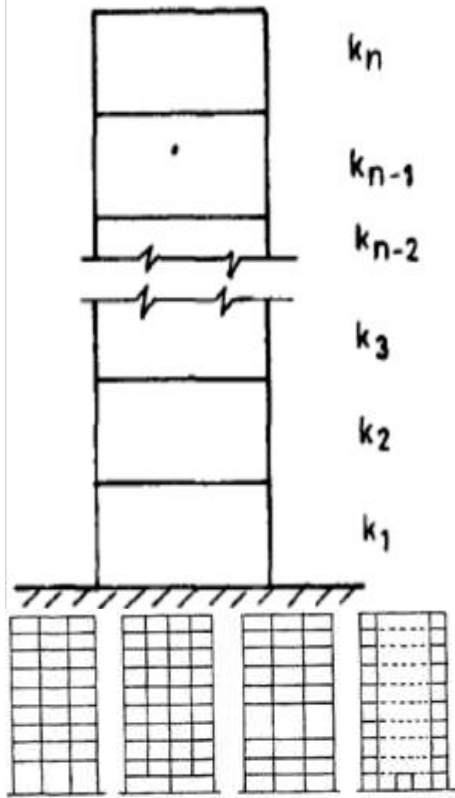

STOREY STIFFNESS FOR THE BUILDING

SOFT STOREY WHEN

$$k_i < 0.7 k_{i+1}$$

$$\text{OR } k_i < 0.8 \left( \frac{k_{i+1} + k_{i+2} + k_{i+3}}{3} \right)$$

(ii)

**Mass Irregularity:** Mass irregularity shall be considered to exist where the seismic weight of any storey is more than 200percent of that of its adjacent storeys. The irregularity need not be considered in case of roofs

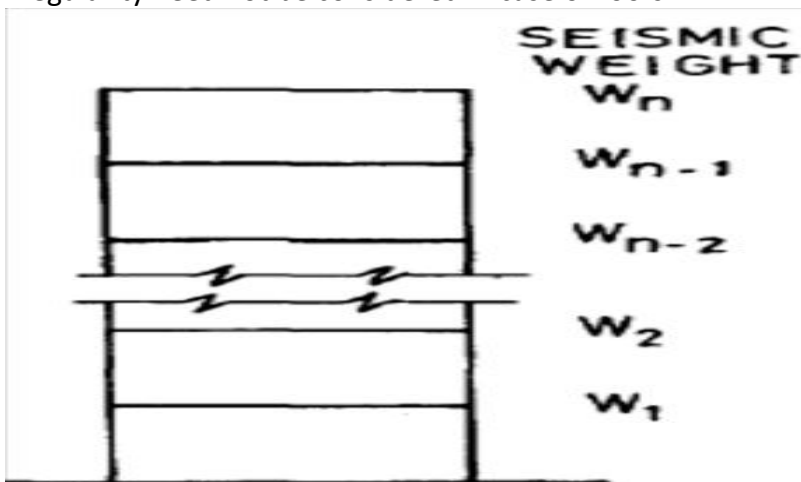

SEISMIC WEIGHT  
 $W_n$   
 $W_{n-1}$   
 $W_{n-2}$   
 $W_2$   
 $W_1$

MASS IRREGULARITY  
 WHEN,  $W_i > 2.0 W_{i-1}$   
 OR  $W_i > 2.0 W_{i+1}$

(iii)

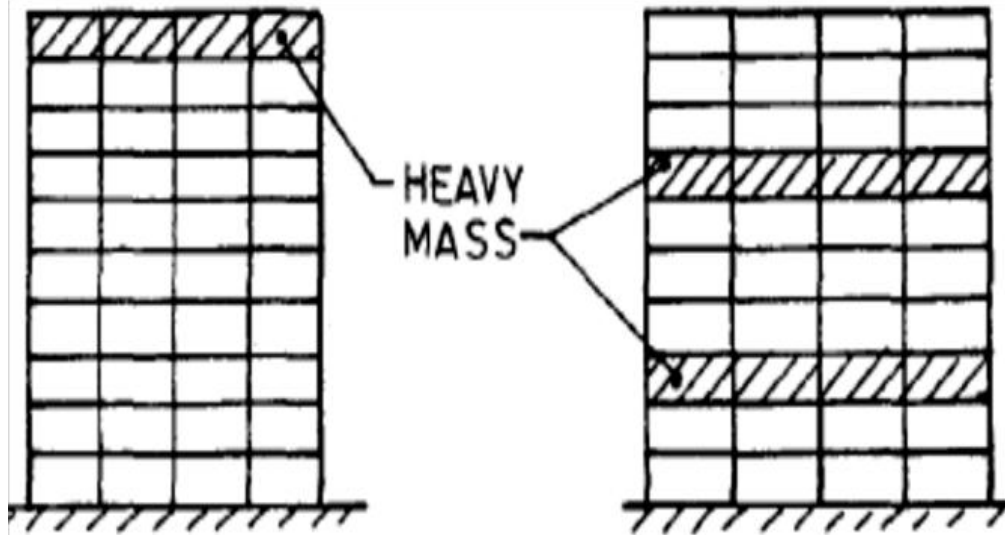

### MASS RATIO

**Vertical Geometric Irregularity:** Vertical geometric irregularity shall be considered to exist where the horizontal dimension of the lateral force resisting system in any storey is more than 150 percent of that in its adjacent storey

(iv)

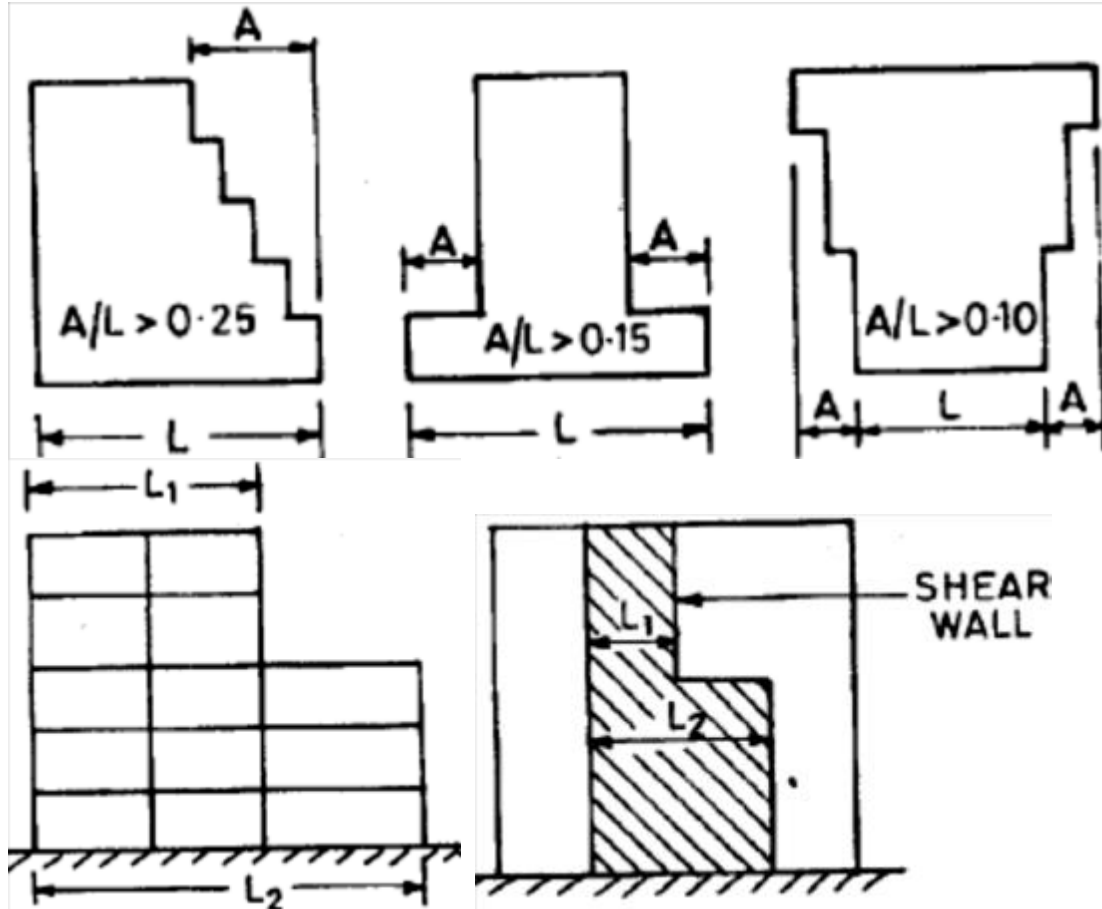

Vertical Geometric Irregularity when  $L_2 > 1.5 L_1$



***In-Plane Discontinuity in Vertical Elements Resisting Lateral Force:*** A in-plane offset of the lateral force resisting elements greater than the length of those elements

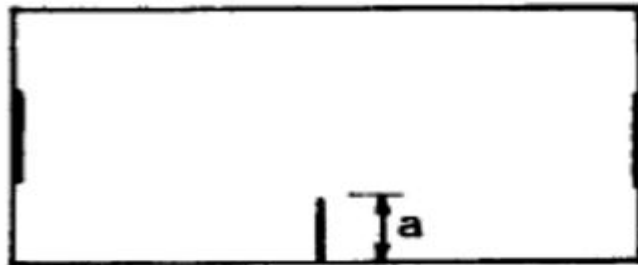
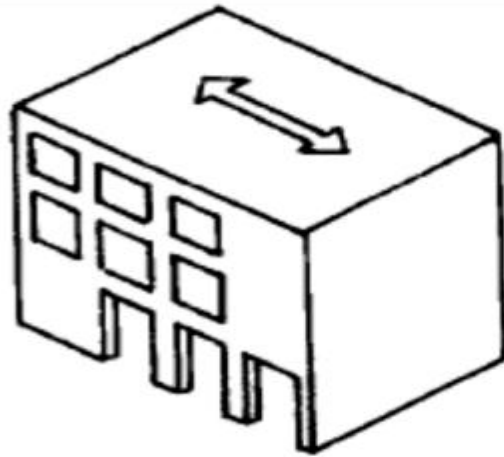

UPPER  
FLOOR

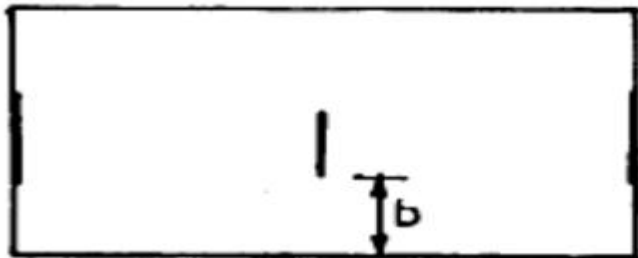

LOWER  
FLOOR

**In-Plane Discontinuity in Vertical Elements Resisting Lateral Force when  $b > a$**

**Weak Storey when  $F_i < 0.8F_{i+1}$  Weak Storey when  $F_i < 0.8F_{i+1} + 1$**

(v)

## STOREY STRENGTH (LATERAL)

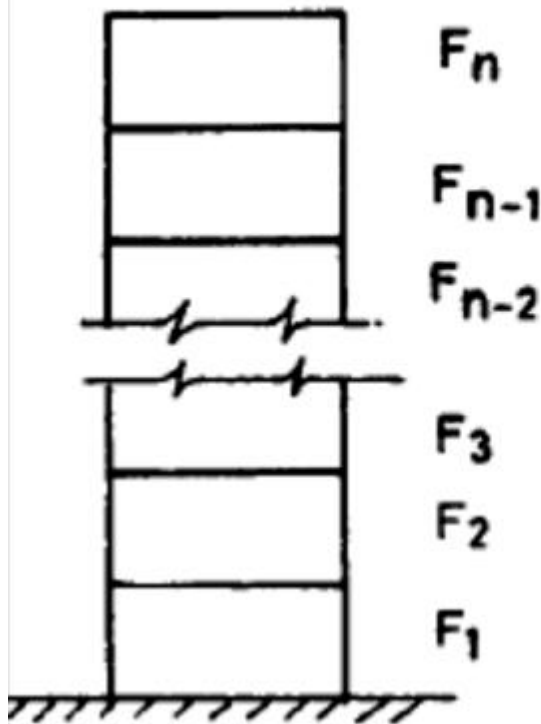

**Weak Storey when  $F_i < 0.8F_{i+1}$**

**Discontinuity in Capacity – Weak Storey:** A weak storey is one in which the storey lateral strength is less than 80 percent of that in the storey above, The storey lateral strength is the total strength of all seismic force resisting elements sharing the storey shear in the considered direction.

### Dynamic Characteristics of Building

#### Dynamic Characteristics

Buildings oscillate during earthquake shaking. The oscillation causes inertia force to be induced in the building. The intensity and duration of oscillation, and the amount of inertia force induced in a building depend on features of buildings, called dynamic characteristics of building. The important dynamic characteristics of buildings are:

- a) Modes of Oscillation
- b) Damping

A mode of oscillation of a building is defined by associated Natural Period and Deformed Shape in which it oscillates. Every building has a number of natural frequencies, at which it offers minimum resistance to shaking induced by external effects (like earthquakes and wind) and internal effects (like motors fixed on it). Each of these natural frequencies and the associated deformation shape of a building constitute a Natural Mode of Oscillation.

The mode of oscillation with the smallest natural frequency (and largest natural period) is called the **Fundamental Mode**; the associated natural period  $T_1$  is called the **Fundamental Natural Period**.

### Natural Period

Natural Period ( $T_n$ ) of a building is the time taken by it to undergo one complete cycle of oscillation. It is an inherent property of a building controlled by its mass  $m$  and stiffness  $k$ . These three quantities are related by

$$T_n = 2\pi\sqrt{\frac{m}{k}}$$

Its unit is second (s).

### Natural Frequency

The reciprocal ( $1/T_n$ ) of natural period of a building is called the Natural Frequency  $f_n$ ; its unit is Hertz (Hz).

### Factors influencing Natural Period

**Effect of Stiffness:** Stiffer buildings have smaller natural period.

**Effect of Mass:** Heavier buildings have larger natural period.

**Effect of Column Orientation:** Buildings with larger column dimension oriented in the direction reduces the translational natural period of oscillation in that direction.

**Effect of Building Height:** Taller buildings have larger natural period.

**Effect of Unreinforced Masonry Infills:** Natural Period of building is lower when the stiffness contribution of URM infill is considered

### Mode Shape

*Mode shape* of oscillation associated with a natural period of a building is the deformed shape of the building when shaken at the natural period. Hence, a building has as many mode shapes as the number of natural periods.

The deformed shape of the building associated with oscillation at *fundamental* natural period is termed its *first mode shape*. Similarly, the deformed shapes associated with oscillations at *second, third*, and other higher natural periods are called *second mode shape, third mode shape*, and so on, respectively.

### Fundamental Mode Shape of Oscillation

As shown in Fig. 7.6, there are three basic modes of oscillation, namely,

1. Pure translational along X-direction,
2. Pure translational along Y-direction and
3. Pure rotation about Z-axis

### Regular buildings

These buildings have pure mode shapes. The *Basic modes of oscillation* i.e. two translational and one rotational mode shapes.

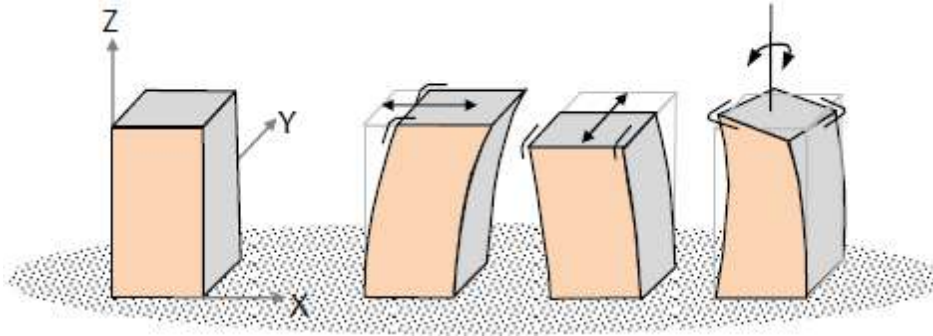

Fig-Basic modes of oscillation

### Irregular buildings

These buildings that have irregular geometry, non-uniform distribution of mass and stiffness in plan and along the height have mode shapes, which are a mixture of these pure mode shapes. Each of these mode shapes is independent, implying, it cannot be obtained by combining any or all of the other mode shapes.

- a) **Fundamental and two higher translational modes of oscillation along X-direction of a five storey benchmark building:** First modes shape has one zero crossing of the un-deformed position, second two, and third three.
- b) **Diagonal modes of oscillation:** First three modes of oscillation of a building symmetric in both directions in plan; first and second are diagonal translational modes and third rotational
- c) **Effect of modes of oscillation on column bending:** Columns are severely damaged while bending about their diagonal direction

### Construction of Framed Structure

#### Behaviour of RC Building in Gravity Loading and Earthquake Loading

In recent times, *reinforced concrete* buildings have become common in India, particularly in towns and cities. A typical RC building consists of horizontal members (*beams* and *slabs*) and vertical members (*columns* and *walls*). The system is supported by *foundations* that rest on ground. The RC frame participates in resisting the gravity and earthquake forces as illustrated in Fig..

#### *Gravity Loading*

1. Load due to self weight and contents on buildings cause RC frames to bend resulting in stretching and shortening at various locations.
2. Tension is generated at surfaces that stretch and compression at those that shorten.
3. Under gravity loads, tension in the beams is at the bottom surface of the beam in the central location and is at the top surface at the ends.

#### *Earthquake Loading*

1. It causes tension on beam and column faces at locations different from those under gravity loading; the relative levels of this tension (in technical terms, bending moment) generated in members are shown in Figure.
2. The level of bending moment due to earthquake loading depends on severity of shaking and can exceed that due to gravity loading.
3. Under strong earthquake shaking, the beam ends can develop tension on either of the top and bottom faces.
4. Since concrete cannot carry this tension, steel bars are required on both faces of beams to resist reversals of bending moment.
5. Similarly, steel bars are required on all faces of columns too.

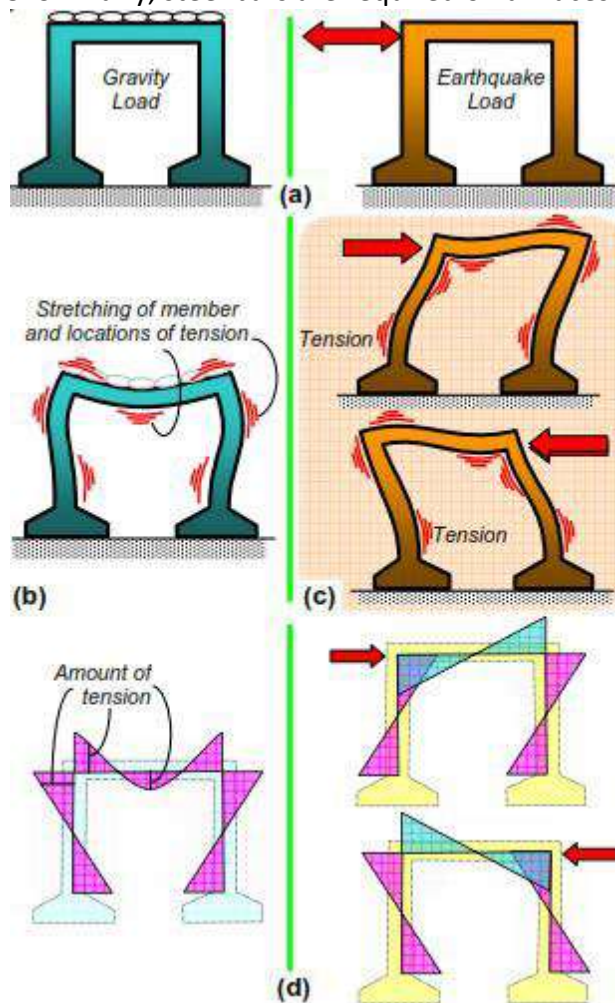
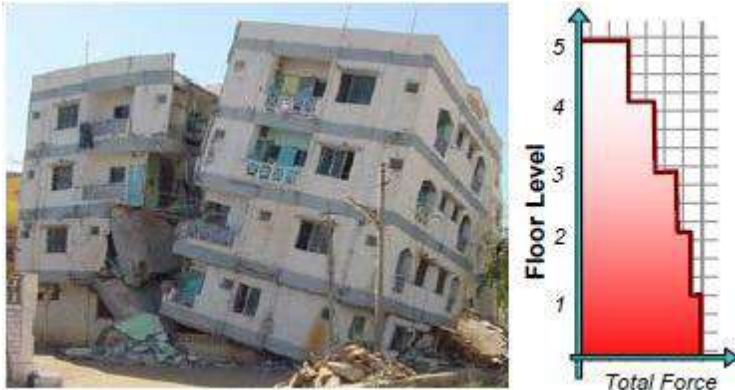

**Fig-Earthquake shaking reverses tension and compression in members – reinforcement is required on both faces of members**

### **Effect of Horizontal Earthquake Force on RC Buildings**

Earthquake shaking generates inertia forces in the building, which are proportional to the building mass. Since most of the building mass is present at floor levels, earthquake-induced inertia forces primarily develop at the floor levels. These forces travel downwards - through

slab and beams to columns and walls, and then to the foundations from where they are dispersed to the ground (Fig. 9.2).



**Fig-Total horizontal earthquake force in a building increase downwards along its height**

As inertia forces accumulate downwards from the top of the building, the columns and walls at lower storeys experience higher earthquake-induced forces and are therefore designed to be stronger than those in storeys above.

#### **Capacity Design Concept**

(i) Let us take two bars of same length & Cross-sectional area

1st bar – Made up of Brittle Material

2nd bar – Made up of Ductile Material

(ii) Pull both the bars until they break

(iii) Plot the graph of bar force  $F$  versus bar elongation. Graph will be as given in Fig. 9.3.

(iv) It is observed that –

a) Brittle bar breaks suddenly on reaching its maximum strength at a relatively small elongation.

b) Ductile bar elongates by a large amount before it breaks.

Materials used in building construction are steel, masonry and concrete. Steel is ductile material while masonry and concrete are brittle material.

Capacity design concept ensures that the brittle element will remain elastic at all loads prior to the failure of ductile element. Thus, brittle mode of failure i.e. sudden failure has been prevented.

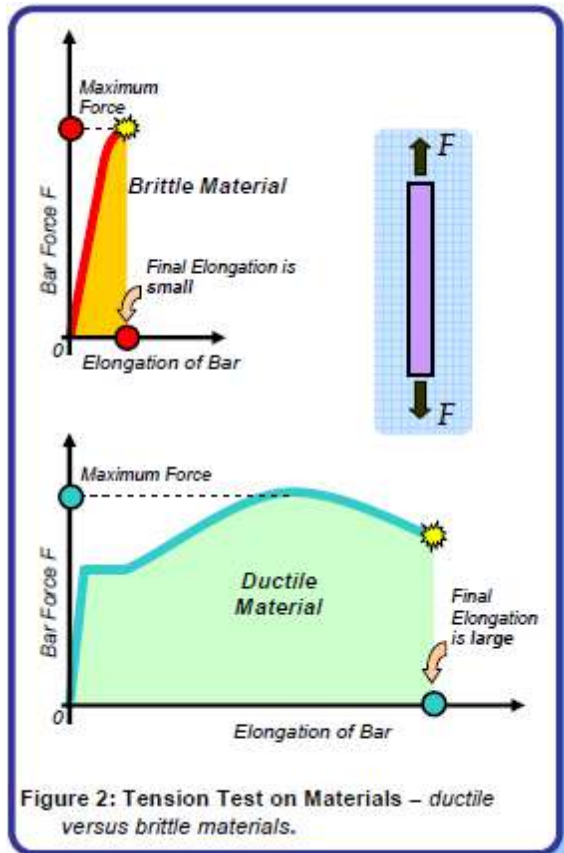

The concept of capacity design is used to ensure post-yield ductile behaviour of a structure having both ductile and brittle elements. In this method, the ductile elements are designed and detailed for the design forces. Then, an upper-bound strength of the ductile elements is obtained. It is then expected that if the seismic force keeps increasing, a point will come when these ductile elements will reach their upper-bound strength and become plastic. Clearly, it is necessary to ensure that even at that level of seismic force, the brittle elements remain safe.

### Ductility and Energy Dissipation

From strength point of view, oversized structures need not necessarily demonstrate good ductility. By ductility of Moment Resisting Frames (MRF), one refers to the capacity of the structure and its elements to undergo large deformations without losing either strength or stiffness. It is important for a building in a seismic zone to be resilient i.e. absorb the shock from the ground and dissipate this energy uniformly throughout the structure.

In MRFs, the dissipation of the input seismic energy takes place in the form of flexural yielding, and resulting in the formation of plastic moment hinges. Due to cyclic nature of the flexural effects, both positive and negative plastic moment hinges may be formed.

### 'Strong Column – Weak Beam' Philosophy

Because beams are usually capable of developing large ductility than columns which are subjected to significant compressive loads, many building frames are designed based on the 'strong column – weak beam' philosophy. Figure shows that for a frame designed according to the 'strong column – weak beam' philosophy to form a failure mechanism, many more plastic hinges have to be formed than a frame designed according to the "weak column – strong beam'

philosophy. The frames designed by the former approach dissipate greater energy before failure.

When this strategy is adopted in design, damage is likely to occur *first* in beams. When beams are detailed properly to have large ductility, the building as a whole can deform by large amounts despite progressive damage caused due to consequent yielding of beams.

*Note: If columns are made weaker, they suffer severe local damage, at the top and bottom of a particular storey. This localized damage can lead to collapse of a building, although columns at storeys above remain almost undamaged*

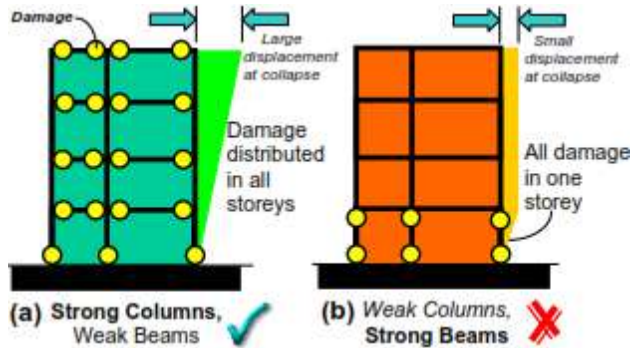

For a building to remain safe during earthquake shaking, columns (which receive forces from beams) should be stronger than beams, and foundations (which receive forces from columns) should be stronger than columns.

### Rigid Diaphragm Action

When beams bend in the vertical direction during earthquakes, these thin slabs bend along with them. And, when beams move with columns in the horizontal direction, the slab usually forces the beams to move together with it. In most buildings, the geometric distortion of the slab is negligible in the horizontal plane; this behaviour is known as the *rigid diaphragm action*. This aspect must be considered during design.

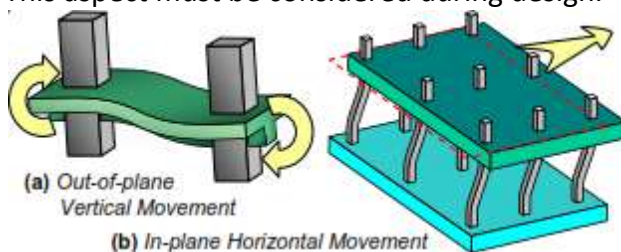

Fig- Floor bends with the beam but moves all columns at that level together.

### Building with Soft storey – Open Ground Storey Building that is vulnerable in Earthquake

The buildings that have been constructed in recent times with a special feature - the ground storey is left *open* for the purpose of parking, *i.e.*, columns in the ground storey do not have any partition walls (of either masonry or RC) between them, are called *open ground storey buildings* or *buildings on stilts*.

An open ground storey building (Fig. 9.6), having *only columns* in the ground storey and *both partition walls and columns* in the upper storeys, have two distinct characteristics, namely:



(a) It is relatively *flexible* in the ground storey, *i.e.*, the relative horizontal displacement it undergoes in the ground storey is much larger than what each of the storeys above it does. This flexible ground storey is also called *soft storey*.

(b) It is relatively *weak* in ground storey, *i.e.*, the total horizontal earthquake force it can carry in the ground storey is significantly smaller than what each of the storeys above it can carry. Thus, the open ground storey may also be a *weak storey*.

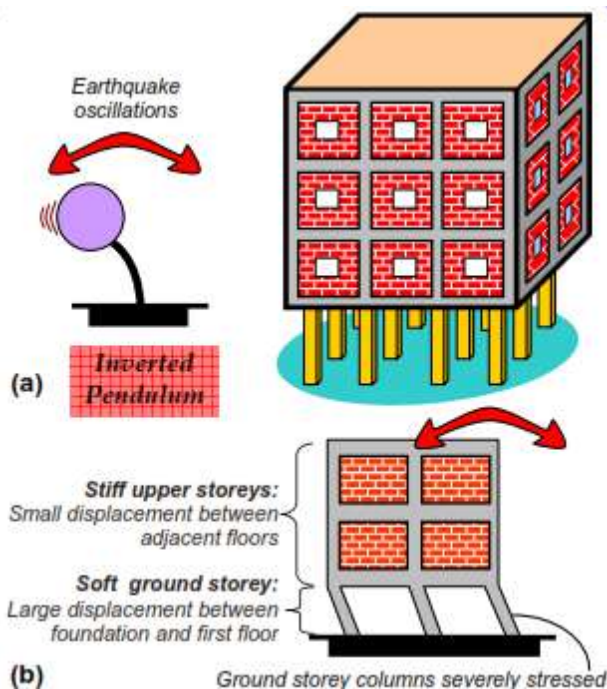

**Fig- Upper storeys of open ground storey building move together as a single block – such buildings are like inverted pendulums**

### **Ductility requirements of Earthquake Resistant Buildings**

The primary members of structure such as beams and columns are subjected to stress reversals from earthquake loads. The reinforcement provided shall cater to the needs of reversal of moments in beams and columns, and at their junctions.

Earthquake motion often induces forces large enough to cause inelastic deformations in the structure. If the structure is brittle, sudden failure could occur. But if the structure is made to behave ductile, it will be able to sustain the earthquake effects better with some deflection larger than the yield deflection by absorption of energy. Therefore, besides the design for strength of the frame, ductility is also required as an essential element for safety from sudden collapse during severe shocks.

The ductility requirements will be deemed to be satisfied if the conditions given as in the following are achieved.

1. For all buildings which are more than 3 storeys in height, the minimum grade of concrete shall be M20 ( $f_{ck} = 20 \text{ MPa}$ )

2. Steel reinforcements of grade Fe 415 (IS 1786: 1985) or less only shall be used.

However, high strength deformed steel bars, produced by the thermo-mechanical treatment process, of grades Fe 500 and Fe 550, having elongation more than 14.5 percent and conforming to other requirements of IS 1786 : 1985 may also be used for the reinforcement.

### **Beams that are required to resist Earthquake Forces in RC Buildings**

In RC buildings, the vertical and horizontal members (*i.e.*, the *columns* and *beams*) are built integrally with each other. Thus, under the action of loads, they act together as a *frame* transferring forces from one to another.

### **General Requirements for Flexural Members**

These members shall satisfy the following requirements.

- The member shall preferably have a width-to-depth ratio of more than 0.3.
- The width of the member shall not be less than 200 mm.
- The depth D of the member shall preferably be not more than 1/4 of the clear span.
- The factored axial stress on the member under earthquake loading shall not exceed  $0.1f_{ck}$ .

### **Longitudinal Reinforcement**

a) The top as well as bottom reinforcement shall consist of at least two bars throughout the member length.

b) The tension steel ratio on any face, at any section, shall not be less than  $p_{min} = 0.24$ ; where  $f_{ck}$  and  $f_y$  are in MPa.

The positive steel at a joint face must be at least equal to half the negative steel at that face.

- The steel provided at each of the top and bottom face of the member at any section along its length shall be at least equal to one-fourth of the maximum negative moment steel provided at the face of either joint. It may be clarified that redistribution of moments permitted in IS 456: 1978 (clause 36.1) will be used only for vertical load moments and not for lateral load moments.
- In an external joint, both the top and the bottom bars of the beam shall be provided with anchorage length, beyond the inner face of the column, equal to the development length in tension plus 10 times the bar diameter minus the allowance for 90 degree bend(s) . In an internal joint, both face bars of the beam shall be taken continuously through the column.

**Fig- Anchorage of Beam Bars in an**

## External Joint (IS 13920: 1993)

### Splicing of longitudinal reinforcement

- The longitudinal bars shall be spliced, only if hoops are provided over the entire splice length, at a spacing not exceeding 150 mm . The lap length shall not be less than the bar development length in tension. Lap splices shall not be provided (a) within a joint, (b) within a distance of  $2d$  from joint face, and (c) within a quarter length of the member where flexural yielding may generally occur under the effect of earthquake forces. Not more than 50 percent of the bars shall be spliced at one section.
- Use of welded splices and mechanical connections may also be made, as per 25.2.5.2 of IS: 456-1978. However, not more than half the reinforcement shall be spliced at a section where flexural yielding may take place.

### Web Reinforcement

Web reinforcement shall consist of vertical hoops. A vertical hoop is a closed stirrup having a  $135^\circ$  hook with a 10 diameter extension (but not  $< 75$  mm) at each end that is embedded in the confined core []. In compelling circumstances, it may also be made up of two pieces of reinforcement; a U-stirrup with a  $135^\circ$  hook and a 10 diameter extension (but not  $< 75$  mm) at each end, embedded in the confined core and a crosstie []. A crosstie is a bar having a  $135^\circ$  hook with a 10 diameter extension (but not  $< 75$  mm) at each end. The hooks shall engage peripheral longitudinal bars.

### Columns that are required to resist Earthquake Forces in RC Buildings

*Columns*, the vertical members in RC buildings, contain two types of steel reinforcement, namely:

- (a) long straight bars (called *longitudinal bars*) placed vertically along the length, and
- (b) closed loops of smaller diameter steel bars (called transverse *ties*) placed horizontally at regular intervals along its full length.

Columns can sustain two types of damage, namely *axial-flexural (or combined compression-bending) failure* and *shear failure*. Shear damage is brittle and must be avoided in columns by providing transverse ties at close spacing.

Closely spaced horizontal closed ties help in three ways, namely

- (i) they carry the horizontal shear forces induced by earthquakes, and thereby resist diagonal shear cracks,
- (ii) they hold together the vertical bars and prevent them from excessively bending outwards (in technical terms, this bending phenomenon is called *buckling*), and
- (iii) they contain the concrete in the column within the closed loops. The ends of the ties must be bent as  $135^\circ$  hooks. Such hook ends prevent opening of loops and consequently bulging of concrete and buckling of vertical bars.

Construction drawings with clear details of closed ties are helpful in the effective implementation at construction site. In columns where the spacing between the corner bars

exceeds 300mm, the Indian Standard prescribes *additional* links with  $180^\circ$  hook ends for ties to be effective in holding the concrete in its place and to prevent the buckling of vertical bars. These links need to go around both vertical bars and horizontal closed ties ; special care is required to implement this properly at site.

Designing a column involves selection of *materials to be used* (i.e. grades of concrete and steel bars), choosing *shape and size of the cross-section*, and calculating *amount and distribution of steel reinforcement*. The first two aspects are part of the overall design strategy of the whole building. The IS 13920 : 1993 requires columns to be at least 300mm wide. A column width of up to 200 mm is allowed if unsupported length is less than 4m and beam length is less than 5m. Columns that are required to resist earthquake forces must be designed to prevent *shear* failure by a skillful selection of reinforcement.

### **General Requirements for Axial Loaded Members**

- These requirements apply to frame members which have a factored axial stress in excess of  $0.1 f_{ck}$  under the effect of earthquake forces.
- The minimum dimension of the member shall not be less than 200 mm. However, in frames which have beams with centre to centre span exceeding 5 m or columns of unsupported length exceeding 4 m, the shortest dimension of the column shall not be less than 300 mm.
- The ratio of the shortest cross sectional dimension to the perpendicular dimension shall preferably not be less than 0.4.

### **Beam-Column Joints that resist Earthquakes Forces in RC Buildings**

In RC buildings, portions of *columns* that are common to *beams* at their intersections are called *beam column joints* . The joints have *limited force carrying capacity*. When forces larger than these are applied during earthquakes, joints are severely damaged. Repairing damaged joints is difficult, and so damage must be avoided. Thus, beam-column joints must be designed to resist earthquake effects.

Under earthquake shaking, the beams adjoining a joint are subjected to moments in the same (clockwise or counter-clockwise) direction.

### **General Requirements for Reinforcing the Beam-Column Joint**

Diagonal cracking and crushing of concrete in joint region should be prevented to ensure good earthquake performance of RC frame buildings.

- Using *large column sizes* is the most effective way of achieving this.
- In addition, *closely spaced closed-loop steel ties* are required around column bars to hold together concrete in joint region and to resist shear forces.
- *Intermediate column bars* also are effective in confining the joint concrete and resisting

horizontal shear forces. Providing closed-loop ties in the joint requires some extra effort.

- IS: 13920–1993 recommends continuing the transverse loops around the column bars through the joint region.

In practice, this is achieved by preparing the cage of the reinforcement (both *longitudinal bars* and *stirrups*) of all beams at a floor level to be prepared on top of the beam formwork of that level and lowered into the cage.

However, this may not always be possible particularly when the beams are long and the entire reinforcement cage becomes heavy. **General Requirements for Reinforcing the Beam-Column Joint** Diagonal cracking and crushing of concrete in joint region should be prevented to ensure good earthquake performance of RC frame buildings.

- Using *large column sizes* is the most effective way of achieving this.
- In addition, *closely spaced closed-loop steel ties* are required around column bars to hold together concrete in joint region and to resist shear forces.
- *Intermediate column bars* also are effective in confining the joint concrete and resisting horizontal shear forces. Providing closed-loop ties in the joint requires some extra effort.
- IS: 13920–1993 recommends continuing the transverse loops around the column bars through the joint region.

In practice, this is achieved by preparing the cage of the reinforcement (both *longitudinal bars* and *stirrups*) of all beams at a floor level to be prepared on top of the beam formwork of that level and lowered into the cage.

However, this may not always be possible particularly when the beams are long and the entire reinforcement cage becomes heavy.

The gripping of beam bars in the joint region is improved *first* by using columns of reasonably large cross-sectional size.

### **Special Confining Reinforcement**

This requirement shall be met with, unless a larger amount of transverse reinforcement is required from shear strength considerations

## CHAPTER 4 RETROFITTING OF STRUCTURES

### COURSE CONTENT

- 4.1 Seismic retrofitting of reinforced concrete buildings :
- 4.2 -Sources of weakness in RC frame building
- 4.3 -Classification of retrofitting techniques and their uses

### What is seismic evaluation?

Seismic evaluation may be understood like the diagnosis of a person with or without ailment on which the direction and nature of treatment depends. Seismic evaluation implies determining the capacity of the structures to resist earthquakes.

### Why the seismic evaluation of a building is a must?

The aim of seismic evaluation is to judge the seismic capacity and vulnerability of buildings during earthquake so that the amount of retrofitting may be determined. There are many deficient buildings, not meeting the current seismic requirements that may suffer extensive damage or even collapse if shaken by an earthquake. This may cause injury to occupants or people living in the vicinity. So, it is necessary to identify weak buildings and to evaluate their capacity for future earthquakes. If required, the buildings must be retrofitted.

### What are the procedures for seismic evaluation?

Numerous methods of seismic evaluation of a building are available depending upon the objective of evaluation and the skill of the evaluator ranging from the visual examination to detailed structural analysis. Each has its own advantage, disadvantage and limitations. The most commonly used methods for the seismic evaluation are;

- **Rapid Visual Screening Procedure (RVSP)** – This method is used for short term evaluation of buildings especially at a time when the frightened occupants refuse to re-enter their houses after an earthquake unless they have been assured that the building is safe for future earthquake.
- **Simplified Evaluation Procedure** – ATC-14 (A Handbook for Seismic Evaluation of Existing Buildings and Supporting Documentations) is a document in which a simplified method of seismic evaluation of different types of buildings is recommended. However it has been modified by a number of Indian conditions and requirements and is available in different ways. The purpose of evaluation is to identify the buildings or building components that are risky to human lives.
- **Visual Inspection Method** – It is generally used in earthquake damaged buildings. Based on the visual observation and modes of failure of building components, one estimates that the particular building may be used in future or not. Sometimes the

help of Non Destructive Testing (NDT) may also be required.

- **Non-linear Static Pushover Procedure** – Non-linear Static Pushover Procedure is used by the design engineers to evaluate the seismic capacity of the building in terms of strength and ductility. It is very helpful to determine the amount of retrofitting required and to further re-evaluate the building after the retrofitting.
- **Non-linear Dynamic Time History Analysis** – This is a method to evaluate building considering dynamic behavior and non-linear material properties. But it requires huge computational effort and time with competent professional softwares. Therefore, most of the design engineers are generally not adopting this method of evaluation.

### **Why seismic retrofitting is required?**

Past earthquakes have manifested that buildings with proper design and construction have borne the seismic shocks without collapse. But the structures either old or constructed without seismic design techniques have undergone serious damage or even collapse with an irreparable loss of innumerable lives. It has been seriously studied that if such buildings are modified to earthquake resistant structures by employing retrofitting techniques, they may be safely reused with no hazard to property and life safety. This also proves to be a better option catering to the economic considerations and immediate shelter problems rather than replacement of buildings. Moreover, retrofitting of buildings is generally more economical as compared to demolition and reconstruction even in the case of severe structural damage.

- **How the retrofitting is defined?**

Seismic retrofitting includes concepts like system behavior improvement, components repair/strengthening up to expected performance i.e. minimum required strength and acceptable damage from an earthquake. Various terms like repair, strengthening, retrofitting, remodeling, rehabilitation, reconstruction etc. are freely employed with a marginal difference;

### **Repairing**

Repairing suggests reconstruction or renewal of any part of a damaged or deteriorated building providing the same level of strength and ductility as was prior to the damage. Sometimes, Repair is also related to the seismic resistance of the building to its pre-earthquake state

<b>Retrofitting</b>	Retrofitting includes upgrading earthquake resistance of either an existing seismically deficient building or earthquake damaged building up to the level of the present day codes by appropriate techniques. Retrofitting also incorporates upgrading of certain building system, such as mechanical, electrical, or structural, to improve performance, function, or appearance.
<b>Remolding</b>	Remolding means reconstruction or renewal of any part of an existing building owing to change of usage or occupancy
<b>Rehabilitation</b>	Rehabilitation encompasses reconstruction or renewal of an earthquake damaged building to provide the level of function, prior to the damage. It also refers to increasing the seismic resistance of an existing seismically deficient building.
<b>Restoration</b>	Rehabilitation of buildings in a certain area may be described as restoration
<b>Strengthening</b>	Reconstruction or renewal of any part of an existing building to provide better structural capacity i.e. higher strength and ductility than the original building, is taken as strengthening. Sometimes the term strengthening and retrofitting are used simultaneously.

### **What are the causes that make a building seismically deficient?**

#### **For existing seismic deficient buildings**

- The buildings have been designed according to a seismic code, but the code has been upgraded in the following years
- changes in codes over the past 50 years show that the design force levels have increased with each revision and the detailing requirements have been made more stringent
- Buildings are designed to meet the modern seismic codes, but the deficiencies exist in the design and /or construction;
- Existing reinforced concrete (RC) frame buildings with non-ductile detailing
- Essential buildings must be strengthened like hospitals, school & colleges, historical monuments and architectural buildings;
- Important buildings whose service is assumed to be essential even just after an



earthquake;

- Buildings, the use of which has changed through the years;
- Buildings those are expanded, renovated or rebuilt.

#### **For earthquake damaged buildings**

- Immediate and long terms safety of the occupants since all the damaged buildings can not be replaced or rebuilt
- Economic consideration since the retrofitting, in general, is more costefficient than reconstruction of buildings
- Important, historical, heritage buildings should be preserved at any cost

#### **What are the causes that make a building seismically deficient?**

#### **For existing seismic deficient buildings**

- The buildings have been designed according to a seismic code, but the code has been upgraded in the following years
- changes in codes over the past 50 years show that the design force levels have increased with each revision and the detailing requirements have been made more stringent
- Buildings are designed to meet the modern seismic codes, but the deficiencies exist in the design and /or construction;
- Existing reinforced concrete (RC) frame buildings with non-ductile detailing
- Essential buildings must be strengthened like hospitals, school & colleges, historical monuments and architectural buildings;
- Important buildings whose service is assumed to be essential even just afteran earthquake;
- Buildings, the use of which has changed through the years;
- Buildings those are expanded, renovated or rebuilt.

#### **For earthquake damaged buildings**

- Immediate and long terms safety of the occupants since all the damaged

buildings can not be replaced or rebuilt

- Economic consideration since the retrofitting, in general, is more costefficient than reconstruction of buildings
- Important, historical, heritage buildings should be preserved at any cost

### **What are the concepts of retrofitting?**

Aim of retrofitting is to (i) upgrade of the lateral strength of the structure (ii) increase the ductility of structure (iii) increase in strength and ductility

### **What is the classification of retrofitting techniques?**

Two alternative approaches are conceptually adopted and implemented in practice for seismic retrofitting: the first approach focuses on reduction of earthquake induced forces (i.e. modifying the demand) and the second focuses on upgrading the structure to resist earthquake induced forces (i.e. modifying the capacity). While applying the first approach, base isolation or damping devices are commonly applied to the structure. An upgraded structural capacity is achieved either by intervening on specific elements or by changing the load paths within the structure<sup>38</sup>.

### **Structural Level (or Global) Retrofit Methods**

Structural-level approach of retrofitting which involves global modifications to the structural system

### **Conventional Methods (modifying the capacity)**

- Adding New Shear Walls into/onto the Existing Frames
- Adding Steel Bracing into/onto the Existing Frame
- Adding Infill Walls into/onto the Existing Frames

## **Non-Conventional Approach** (modifying the dema

- Seismic Base Isolation
- Supplemental Damping Devices

### **Member Level (or Local) Retrofit Methods**

Member level approach of retrofitting or local retrofitting of components withadequate capacities to satisfy their specific limit states. It includes jacketing/confinement of Columns, Beam, Beam-Column Joint, Slab, Foundations etc.

### **What are the considerations in retrofitting of buildings?**

Seismic retrofitting is constrained to certain areas of an existing building. In such cases, the retrofitted structure is a “behavioral hybrid” system consisting of strong/ductile components (added elements) and of weak/brittle components (elements that are not strengthened). In the event of an earthquake, all components at each floor, retrofitted or not, will undergo the same lateral displacements. While modified or added elements can be designed to sustain these lateral deformations, the remaining non-strengthened elements could still suffer substantial damage. Therefore, it is suggested that the design of retrofitted schemes should be based on drift control rather than on strength consideration alone and should be able to predict initial and final stiffness ofthe retrofitted structure.

### **What are considerations for retrofitting of a building using shear walls into/onto the existing frames?**

Addition of new RC walls is the most common method for strengthening of existing structures. Special consideration is needed to the distribution of the walls in plan and elevation (to achieve a regular building configuration), transfer of inertial forces to the walls through floor diaphragms, integration and connection of the wall into the existing frame buildings and transfer of loads to the foundations. Added walls are typically designed and detailed as in new structures which are designed to carry all or most of the lateral force. These systems simply bypass the existing inadequate system and the need to correct all or most of the deficiencies in the old structure. The main difficulty with this retrofitting scheme is that the lateral forces are concentrated in certain areas where shear walls are added and these walls impose large forces on the foundation. Therefore, new foundations or strengthening of the existing foundations may be required to resist the increased overturning moment and the increased dead load of the structure. Foundation intervention is usually costly and

quite disruptive, thus rendering the application of this technique is unsuitable for buildings without an existing adequate foundation system. This could be inconvenient in cases where the strengthening project, or when there is not enough or no information on the original foundation design.

### Limitations

- Increase in lateral resistance but it is concentrated at a few places
- Increased overturning moment at foundation causes very high uplifting that needs either new foundations or strengthening of the existing foundations
- Increased dead load of the structure
- Excessive destruction at each floor level results in functional disability of the buildings
- Possibilities of adequate attachment between the new walls and the existing structure
- Closing of formerly open spaces can have major negative impact on the interior of the building uses or exterior appearance

### How far steel bracing is effective as retrofitted technique?

Steel bracing is commonly used in RC framed buildings if heavy reinforced concrete shear walls cannot be supported by existing foundation. Steel bracing can be a very effective method for global strengthening of buildings. Some of the advantages of steel bracing over the shear wall are the ability to accommodate openings, construction work can be performed externally to the building to minimize disruption of the occupants and increase speed of work; small increase in mass, as a result foundation and construction costs may be minimized. But care must be taken to produce a final design that is structurally well balanced i.e. no stiffness irregularity in plan or along the height. Coordination between building owner, engineer and architect is essential to satisfy architectural and functional requirements.

### Limitations

- Lack of information on the seismic behavior of the added bracing
- The connection between an existing framing system and added elements should be carefully detailed because forces must be transferred between the existing and added structural system.
- A moderate to high level skilled labor is necessary for construction, due to the need for member fit-up adjustment and welding.
- Close quality control particularly with respect to welding is essential.

The steel bracing may be applied either externally or internally. In the external bracing system, steel bracing systems are attached to the exterior frames which

create minimum disruption to the function of the building and its occupants and also provide better feeling of security. In case of internal bracing, the buildings are retrofitted by incorporating a bracing system inside the individual bays of the RC frames. The bracing may be attached to the RC frame either indirectly or directly. Different forms of steel bracing such as X, V and K may be used. Cable braces may also be used on a low-rise structure. The cables could be added quickly and with minimal disruption to the occupants. In addition, the cable braces required minimal modification to existing structure. End blocks are provided to hold the cable anchorages at the foundation level and at the roof.

The bracing system should be designed for elastic response, but detailed for ductile behavior. It is desirable to limit the effective slenderness ratio of the braces to 100, and preferably to 80 to limit inelastic buckling therefore it is effective in compression as well as tension. Such bracing members have been shown to exhibit better-absorbing characteristics than braces with higher effective slenderness ratios. Therefore the designer must control the slenderness ratio by selecting the bracing layout and the brace section. Inelastic buckling of the braces is the main problem in achieving good hysteretic ductility.

What are considerations for retrofitting a building by infill **walls into/onto the existing frames?**

A convenient way to introduce infill walls may be by partial or full infilling of strategically selected bays of the existing frame. The infill wall may be provided in a bay consisting of beams and the two columns and the latter acting as its boundary elements. In case of increasing the capacity of existing infill shotcrete is normally used. Pre-cast panels may also be a good alternative in place of cast-in-place infill walls. These walls, well anchored into the surrounding frame with various types of connections (e.g., shear keys, dowels, chemical anchors etc.), not only increase the lateral stiffness of the building significantly, but also relieve the existing non-ductile frames from being subjected to large lateral force demands

How far external buttresses help to reduce the seismic **vulnerability of an RC building?**

External buttresses increase the lateral resistance of the structure as a whole. It requires a new foundation system. There are two most intricate problems in retrofitting; (i) the buttress stability (ii) the connections between the buttresses and of the building. The buttress should be connected to the floors and columns at all levels to ensure full interaction and resisting the lateral loads. The connection area will be subjected to unusual levels of stresses that require special attention.

**What is seismic base isolation technique and how can it be used in retrofitting of buildings?**

Seismic base isolation is recommended for retrofitting of critical or essential facilities, buildings with expensive and valuable contents and structures. It significantly reduces the seismic impact on the building and assemblies. Seismic isolation involves the insertion of flexible or sliding bearings at one level of a building. The isolation devices are inserted at the bottom or at the top of the

first floor columns. Seismic isolation is more appropriate for buildings of historic significance because it may be applied without much disturbance to the historical architectural features. However, inserting an isolator within an existing column is not so simple because of the necessity of cutting the element, temporarily supporting the weight of the above structure, putting in place the isolators and then giving back the load to the column, without causing damage to persons and to structural and non-structural elements

#### **MEMBER LEVEL RETROFIT METHOD**

To strengthen individual components, structural members and their connections can be retrofitted and/or strengthened by reinforced concrete or steel jacketing, or by fiber reinforced plastic (FRP) or carbon fiber wrapping called local retrofitting. The local modification of isolated components of the structural and non-structural system aims to increase the deformation capacity of deficient components. Local intervention techniques are applied to a group of members that suffer from structural deficiencies and a combination of these techniques may be used in order to obtain the desired behavior for a seismically designed structure.

#### **RC JACKETING OF COLUMN**

RC jacketing is applied for the rehabilitation of concrete members. If the longitudinal reinforcement placed in the jacket passes through holes drilled in the slab and new concrete is placed in the beam-column joint, it is categorized as global intervention which improves flexural strength of the column but strength of the beam-column joints remains the same. If the longitudinal reinforcement stops at the floor level then RC jacketing is considered as a member intervention technique which improves the axial and shear strength of the column. It has several advantages like avoiding the concentrations of lateral load resistance; no major changes in the original geometry of building; the original function of the building can be maintained. However there are some disadvantages. The presence of beams may require most of the new longitudinal bars in the jacket to be bundled into the corners of the jacket; it is difficult to provide cross ties for the new longitudinal bars which are not at the corners of the jacket; lack of guidelines.

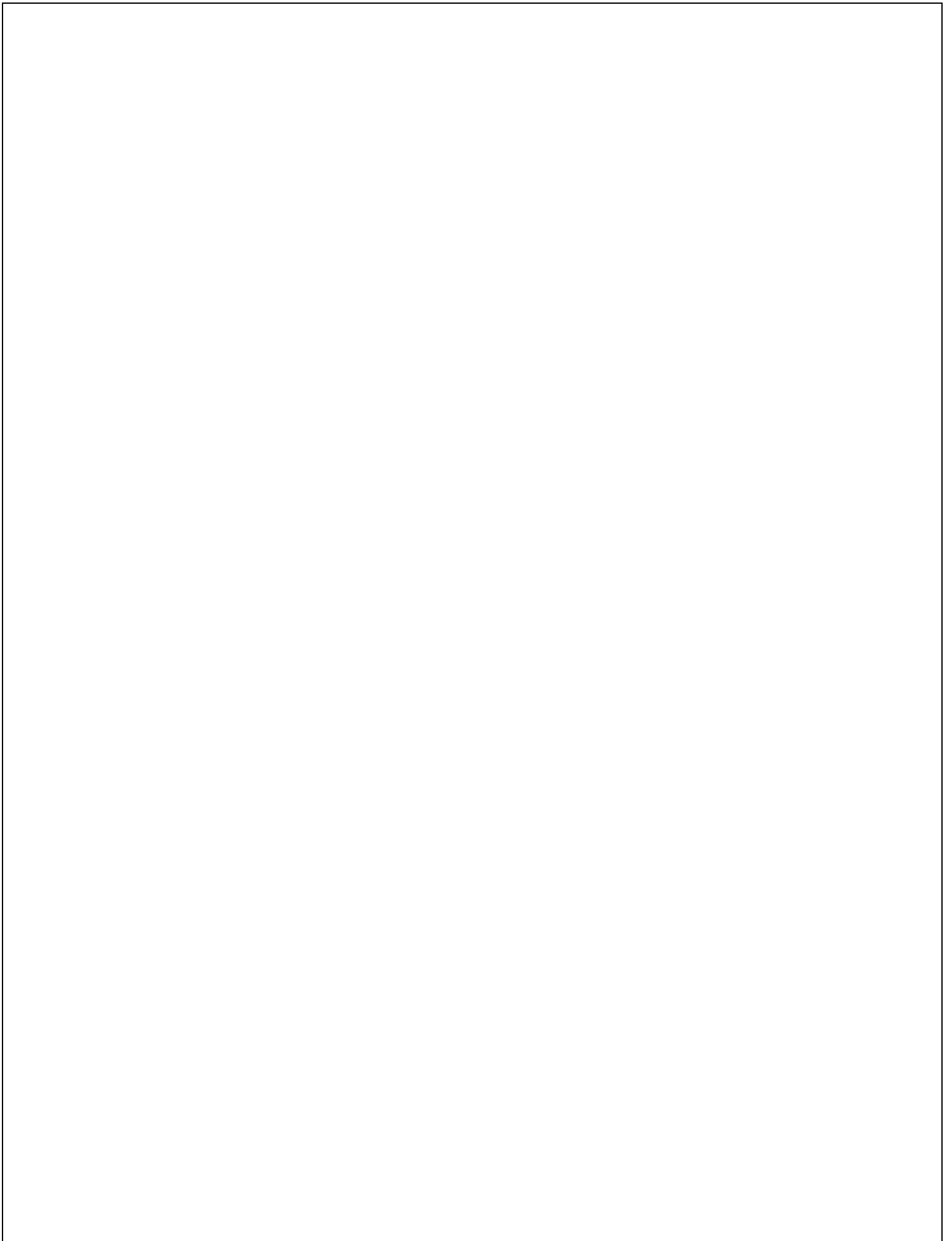

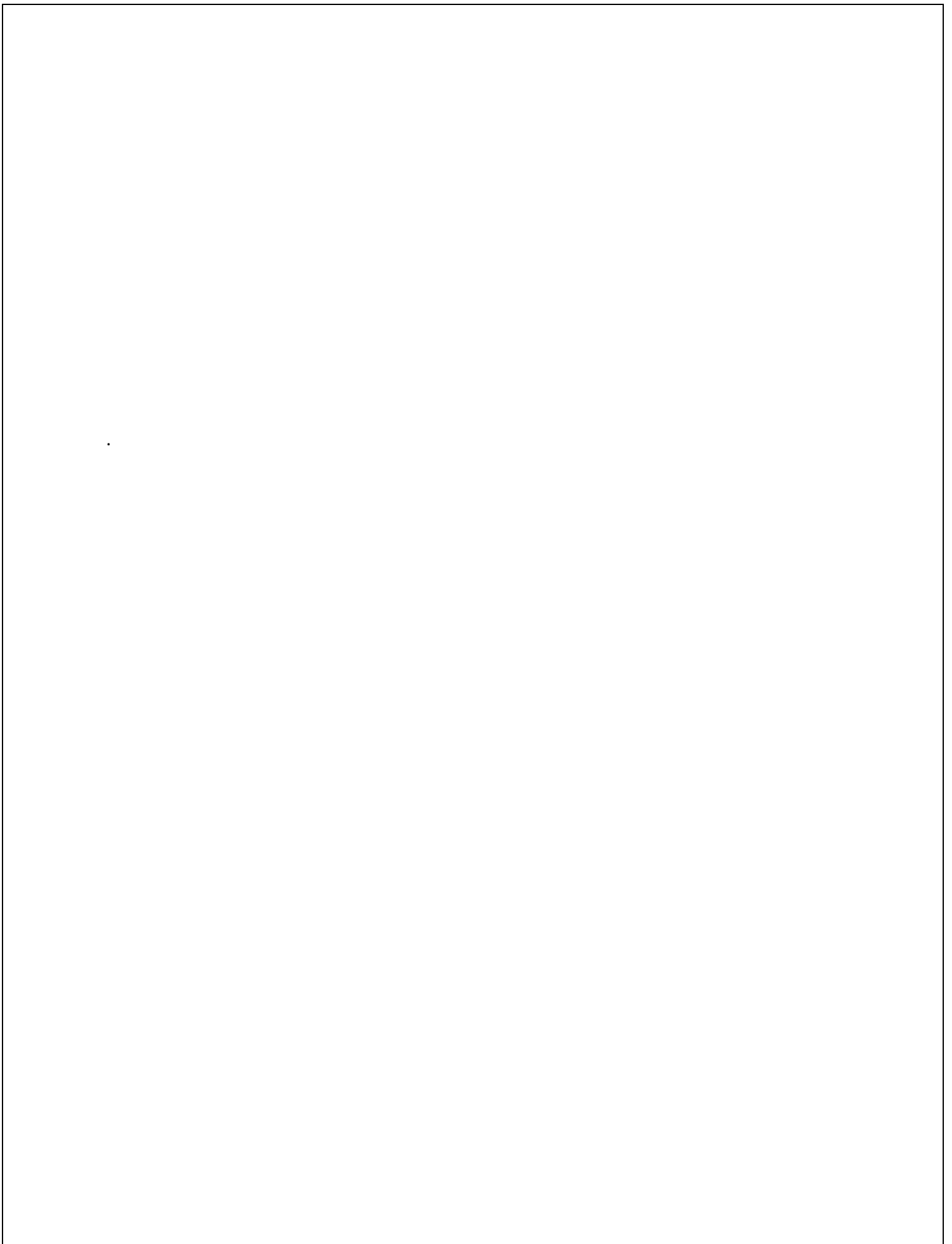



-