



# **S.K D.A.V GOVERNMENT POLYTECHNIC**

## **LECTURE NOTE ON HIGHWAY ENGINEERING**

**BRANCH-CIVIL ENGINEERING  
SEMESTER-4<sup>TH</sup> SEMESTER**

**PREPARED BY:  
MISS BANITA MAHARANA  
LECTURER, CIVIL**

## **UNIT 1- INTRODUCTION**

### **Importance of Highway transportation:**

Highway transportation is the means of detail distribution between homes, shops, factories, etc. It is only the roads which can carry goods from and to aerodromes, harbours and railway stations. Considering the utility of roads anywhere in the different parts of a country, they can be rightly compared to arteries in a human body just as arteries maintain man's health by providing circulation of blood; similarly roads promote nation's wealth by keeping its people and goods moving. Thus, we see that progress and well-being of a nation depends much on roads. In fact, roads are the life lines of nation's economy.

The importance or necessity of highway transportation can be easily judged from the following purposes or advantages of roads:-

They facilitate conveyance of people, goods, raw-materials, manufactured articles, etc. speedily and easily in the different parts of a country.

1. They act as the only source of communication in regions of high altitude *i.e* in mountainous regions.
2. They help in growth of trade and other economy activities in and outside the villages and towns by establishing contact between towns and villages.
3. They help in providing efficient distribution of agricultural products and natural resources all over the country.
4. They help in price stabilization of commodities due to mobility of products all over the country.
5. They help in social and cultural advancement of people and making the villagers active and alert members of the community.
6. They help in promoting the cultural and social ties among people living in different part of a country and thus strengthen the national unity.
7. They help in providing improved medical facilities quickly to human beings, especially to those who live in rural areas.
8. They provide more employment opportunities.
9. They enhance land value and thus bring better revenue.
10. They serve as feeders for Airways, Waterways and Railways.
11. They help in reducing distress among the people, caused due to famine, by supplying them food and clothing quickly.

Lastly, it can be sad that roads are the symbol of country's progress and thus development made by any country can be judged by the quality and network of its road system.

### **Indian roads congress:**

Indian Roads Congress (IRC) was set up by the Government of India in December, 1934 on the recommendations of Jayakar Committee with the objective of promoting and encouraging the science for building and maintenance of roads. It also provides a national forum for sharing of knowledge and pooling of experience on the entire range of subjects dealing with the construction and maintenance of roads and bridges. IRC has now about 13,500 members comprising of engineers of all ranks from Central and State Governments, Engineering Services of Army, Border Roads Organization, Road Research Institutes, Engineering Colleges, Local Bodies and private enterprises.

### **Functions of Indian Roads Congress(IRC) :**

IRC a body of professional highway engineers provides the following services:

- I. It provides a forum for expression of collective opinion of its members for all matters affecting the construction and maintenance of roads in India.
- II. It promotes the use of the standard specifications and practices.
- III. It provided with the suggestions for the better methods of planning, designing, construction, administration and maintenance of roads.
- IV. It conducts periodical meetings to discuss technical problems regarding roads.
- V. It makes the laws for the development, improvement and protection of the roads.
- VI. It furnishes and maintains libraries and museums for encouraging the science of road making.

### **Functions of Central Road Research Institute (CRRI):**

CRRI was started by the Central Government in 1950, for the research work in the highway engineering. CRRI is a series of laboratories under the council of scientific and industrial research in India. It offers the following services:

1. Carries basic and applied research for the design, construction and maintenance of the highways.
2. Carries research on traffic safety and transport economics.
3. Carries research on economical utilization of locally available materials for construction and maintenance of roads.
4. Research for the development of the new machinery, tools equipment and instruments for highway engineering.
5. To provide technical advice and consultancy services to various organizations.
6. To provide library and documentation services.

### **Ministry of Surface Transport:**

The **Ministry of Road Transport and Highways** is a ministry of the Government of India, that is the apex body for formulation and administration of the rules,

regulations and laws relating to road transport, transport research and also to increase the mobility and efficiency of the road transport system in India. Through its officers of Central Engineering Services (Roads) cadre it is responsible for the development of National Highways of the country. Road transport is a critical infrastructure for economic development of the country. It influences the pace, structure and pattern of development. In India, roads are used to transport over 60 percent of the total goods and 85 percent of the passenger traffic. Hence, development of this sector is of paramount importance for India and accounts for a significant part in the budget.

### **Roads wing of ministry of surface transport:**

The roads wing of the ministry of Surface Transport handles the road matters of the Central Govt. It is headed by a Director General.

The Director General is assisted by two additional Director Generals (one for roads and one for bridges), a number of Chief Engineers, Superintending Engineers, Executive Engineers and Asst. Executive Engineers. The roads wing has a chief Engineer for the North-East region posted at Guwahati and a Liaison-cum-Inspectorate organization consisting of S.E's and E.E's in the various states. The functions of the roads wing of Surface Transport are:

- a. To control funds approved by Central Government for the development of National Highways.
- b. To control the central road fund.
- c. To prepare plans for development and maintenance of National Highways in consultation with state PWD's.
- d. To oversee technically the quality of works executed by the agencies.
- e. To administer matters regarding road research.
- f. To examine technically the projects of roads and bridges prepared by the PWD's.
- g. To administer the central road program other than National Highways in the Union Territories.

### **IRC classification of roads :**

IRC (Indian Roads Congress) has classified the roads in India in the following 5 categories:

- (a) National Highways
- (b) State Highways
- (c) Major District Roads
- (d) Other District Roads
- (e) Village Roads

**National Highways (NH):** National highways are the major arterial roads spanning in the length and breadth of the country and connect the Capital to the various state capitals of the country or with the neighboring countries.

They also connect the famous tourism places of the country. National highways are numbered and written as NH-1, NH-2 etc. They have the highest design specifications.



*Example : NH -1 Delhi-Ambala-Amritsar, NH-21 Chandigarh- Mandi- Manali.*

**State Highways(SH):** State highways are the roads which connect the state capital to other states and to the district headquarters in the state. They have design specifications similar to those of the National Highways because they carry enough traffic.

**Major District Roads(MDR):** These roads connect the district headquarters to the main town centres in the district, and to the headquarters of the other districts also. They also connect these major town centres to the other state highways of importance. They have lower design specifications as compared to the NH and SH.

**Other district roads(ODR):** These roads connect the rural areas town centres to the major district roads of higher importance. They provide the facilities for the transportation of the raw materials or the goods mainly of agricultural products from the rural towns to the higher markets and vice-versa.

**Village Roads (VR):** These roads connect the rural villages with one another and to the nearest higher level road or to the nearest town centre. They have lower design specifications and many of them are not even metalled.

### **Organisation of state highway department**

Responsibility for new construction and maintenance works on the National Highways is under the control of the Chief Engineer National Highways (CE (NH)). The CE (NH) reports to MOST for works carried out on the National Highway network.

This wing has been set up in keeping with the requirements of MOST to:

- Reduce the line of communication between the GOI and State Authorities
- achieve efficiencies in implementation by avoiding the cumbersome and outdated delegations for administrative and technical sanction which limit the ability of the Odisha Works Department to respond quickly

- Achieve uniform maintenance and construction standards on NHs.

At present, 16 Nos. of National Highways measuring 3592.932 km in length traversed through the state of Odisha. Out of 3592.932 km of total length of National Highways in Odisha, 3071.722 km is under the control of NH wing of State PWD, and remaining 521.210 km have been transferred to National Highways Authority of India for improvement under NHDP and Port connectivity.



## UNIT 2- ROAD GEOMETRICS

### Glossary of terms used in geometric and their importance:

#### Right of way

Right of way (ROW) or land width is the width of land acquired for the road, along its alignment. It should be adequate to accommodate all the cross-sectional elements of the highway and may reasonably provide for future development. To prevent ribbon development along highways, control lines and building lines may be provided. Control line is a line which represents the nearest limits of future uncontrolled building activity in relation to a road. Building line represents a line on either side of the road, between which and the road no building activity is permitted at all. The right of way width is governed by:

1. Width of formation: It depends on the category of the highway and width of roadway and road margins.
2. Height of embankment or depth of cutting: It is governed by the topography and the vertical alignment.
3. Side slopes of embankment or cutting: It depends on the height of the slope, soil type etc.
4. Drainage system and their size which depends on rainfall, topography etc.
5. Sight distance considerations: On curves etc. there is restriction to the visibility on the inner side of the curve due to the presence of some obstructions like building structures etc.
6. Reserve land for future widening: Some land has to be acquired in advance anticipating future developments like widening of the road.

**Table :** Normal right of way for open area

Road classification	Roadway width in m	
	Plain and rolling terrain	Mountainous and steep terrain
Open areas		
NH/SH	45	24
MDR	25	18
ODR	15	15
VR	12	9
Built-up areas		
NH/SH	30	20
MDR	20	15
ODR	15	12
VR	10	9

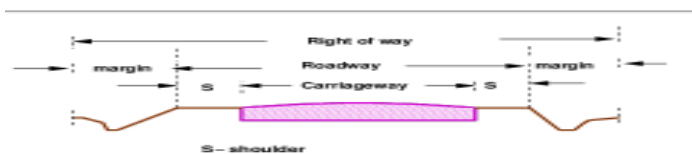

- Width of formation
- Height of embankment
- Side slopes
- Drainage system
- Sight distances consideration on horizontal curves
- Future extension

### Formation width

Width of formation or roadway width is the sum of the widths of pavements or carriage way including separators and shoulders. This does not include the extra land in formation/cutting. The values suggested by IRC are given in Table:

Road classification	Roadway width in m	
	Plain and rolling terrain	Mountainous and steep terrain
NH/SH	12	6.25-8.8
MDR	9	4.75
ODR	7.5-9.0	4.75
VR	7.5	4.0

**Table :** Width of formation for various classed of roads

### Road margin

The portion of the road beyond the carriageway and on the roadway can be generally called road margin. Various elements that form the road margins are given below.

#### 1. Shoulders

Shoulders are provided along the road edge and is intended for accommodation of stopped vehicles, serve as an emergency lane for vehicles and provide lateral support for base and surface courses. The shoulder should be strong enough to bear the weight of a fully loaded truck even in wet conditions. The shoulder width should be adequate for giving working space around a stopped vehicle. It is desirable to have a width of 4.6 m for the shoulders. A minimum width of 2.5 m is recommended for 2-lane rural highways in India.

#### 2. Parking lanes

Parking lanes are provided in urban lanes for side parking. Parallel parking is preferred because it is safe for the vehicles moving on the road. The parking lane should have a minimum of 3.0 m width in the case of parallel parking.

#### 3 .Bus-bays

Bus bays are provided by recessing the kerbs for bus stops. They are provided so that they do not obstruct the movement of vehicles in the carriage way. They should be at least 75 meters away from the intersection so that the traffic near the intersections is not affected by the bus-bay.

#### **4. Service roads**

Service roads or frontage roads give access to access controlled highways like freeways and expressways. They run parallel to the highway and will be usually isolated by a separator and access to the highway will be provided only at selected points. These roads are provided to avoid congestion in the expressways and also the speed of the traffic in those lanes is not reduced.

#### **5 .Cycle track**

Cycle tracks are provided in urban areas when the volume of cycle traffic is high. Minimum width of 2 meter is required, which may be increased by 1 meter for every additional track.

#### **6 .Footpath**

Footpaths are exclusive right of way to pedestrians, especially in urban areas. They are provided for the safety of the pedestrians when both the pedestrian traffic and vehicular traffic is high. Minimum width is 1.5 meter and may be increased based on the traffic. The footpath should be either as smooth as the pavement or more smoother than that to induce the pedestrian to use the footpath.

#### **7 .Guard rails**

They are provided at the edge of the shoulder usually when the road is on an embankment. They serve to prevent the vehicles from running off the embankment, especially when the height of the fill exceeds 3 m. Various designs of guard rails are there. Guard stones painted in alternate black and white are usually used. They also give better visibility of curves at night under headlights of vehicles.

#### **8. Carriage Way**

It is the width of the road which is used by the traffic for moving on it. It is generally central portion of the total land width and is paved and surfaced with the bituminous concrete for service to the road users. Width of the carriage way depends on the number of the lanes in the road which again depends on the class of the highway. If it is higher level road like NH then it will need more numbers of lanes and therefore the carriageway width will be more.

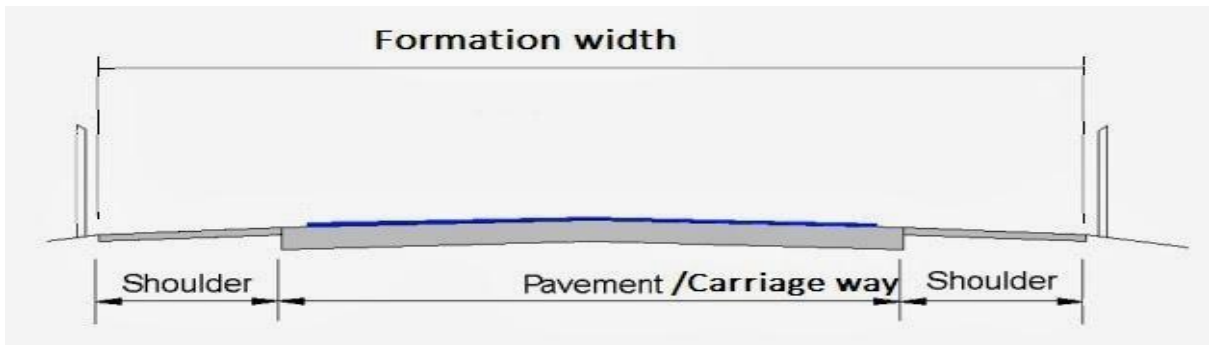

## Side slopes

Side slopes are important in maintaining the stability of the roadbed and pavement structure as well as providing an area for the safety of errant vehicles. Side slopes are constructed in both fill (embankment) areas (those falling above the natural ground level) and cut areas (those falling below the natural ground level). As a general reference, slopes in embankment areas are commonly referred to as fill slopes or front slopes. When it is determined that no parallel ditch section is needed the front slope is graded to meet natural ground. In cut areas, side slopes are referred to as front slopes and back slopes, the back slope being necessary to bring the roadway cross section back up to meet the natural ground level. Ditch sections included as part of either fill or cut sections have a front slope, a ditch bottom with a defined shape and width, and a back slope. Criteria for rates of these slopes (by road classes) are shown in Fig.

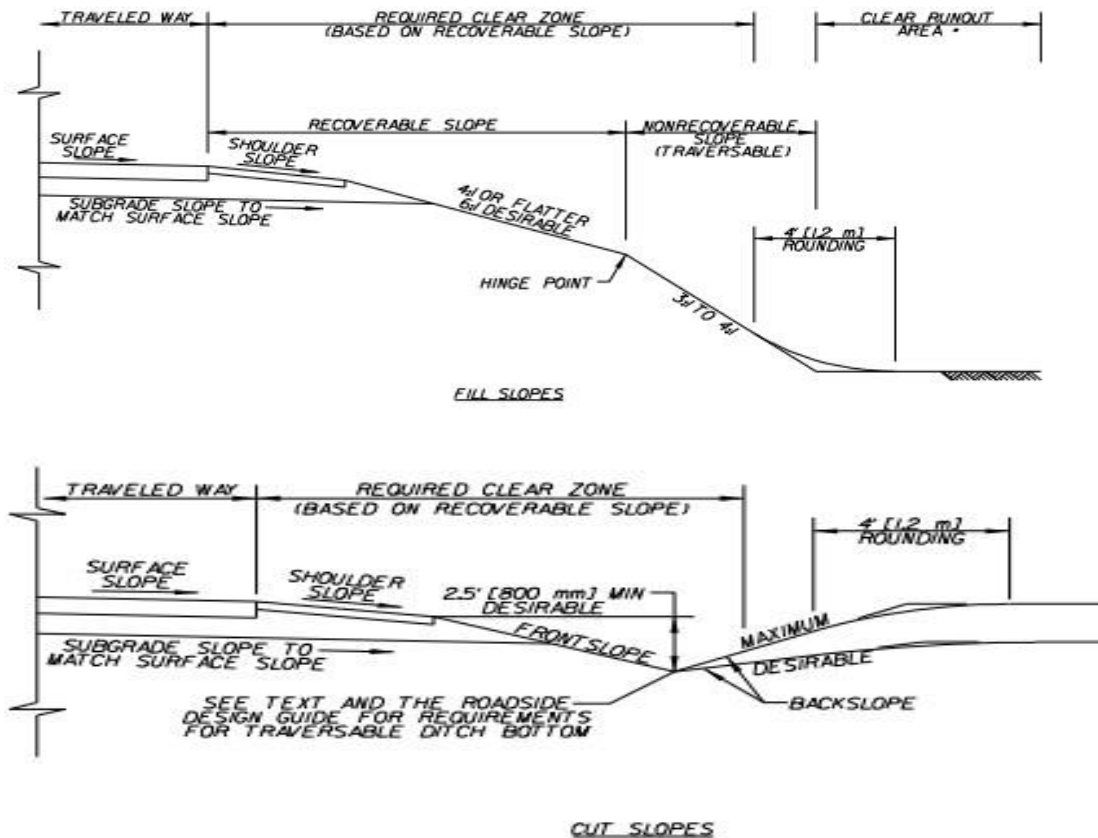

## Kerbs

Kerbs indicate the boundary between the carriage way and the shoulder footpaths. Different types of kerbs are (Figure ):

1. Low or mountable kerbs : This type of kerbs are provided such that they encourage the traffic to remain in the through traffic lanes and also allow the driver to enter the shoulder area with little difficulty. The height of this kerb is about 10 cm above the pavement edge with a slope which allows the vehicle to climb easily. This is usually provided at medians and channelization schemes and also helps in longitudinal drainage.

Semi-barrier type kerbs : When the pedestrian traffic is high, these kerbs are provided. Their height is 15 cm above the pavement edge. This type of kerb prevents encroachment of parking vehicles, but at acute emergency it is possible to drive over this kerb with some difficulty.

2. Barrier type kerbs : They are designed to discourage vehicles from leaving the pavement. They are provided when there is considerable amount of pedestrian traffic. They are placed at a height of 20 cm above the pavement edge with a steep batter.
3. Submerged kerbs : They are used in rural roads. The kerbs are provided at pavement edges between the pavement edge and shoulders. They provide lateral confinement and stability to the pavement.

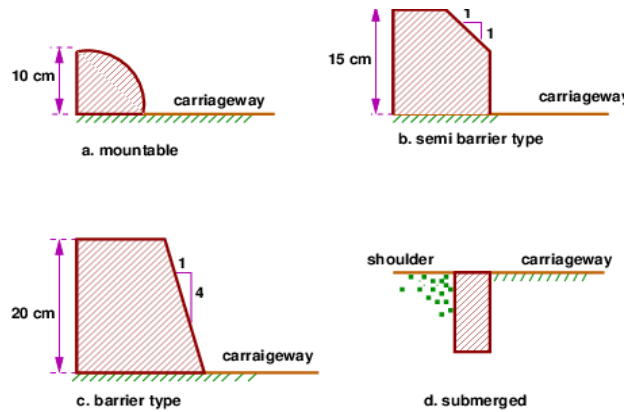

**Figure :** Different types of kerbs

### Formation level

The Formation Level is the level at which excavation ceases and construction commences. It is the lowest point of the path structure. It is the prepared ground on which the sub base layer is laid.

### Camber

Camber or cant is the cross slope provided to raise middle of the road surface in the transverse direction to drain off rain water from road surface. The objectives of providing camber are:

1. Surface protection especially for gravel and bituminous roads
2. Sub-grade protection by proper drainage
3. Quick drying of pavement which in turn increases safety

Too steep slope is undesirable for it will erode the surface. Camber is measured in *1 in n* or *n%* (Eg. 1 in 50 or 2%) and the value depends on the type of pavement surface. The values suggested by IRC for various categories of pavement is given in Table 1. The common types of camber are parabolic, straight, or combination of them (Figure )

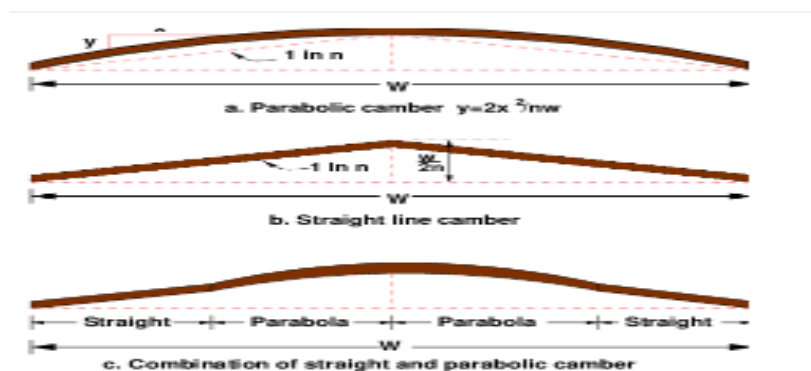

**Figure :** Different types of camber

**Table : IRC Values for camber**

Surface type	Heavy rain	Light rain
Concrete/Bituminous	2 %	1.7 %
Gravel/WBM	3 %	2.5 %
Earthen	4 %	3.0 %

## Gradient

It is the slope provided to the surface of the road in the longitudinal direction for the vertical alignment of the road. There are three kinds of gradients:

- Ruling Gradient
- Limiting Gradient
- Exceptional Gradient
- Minimum Gradient.

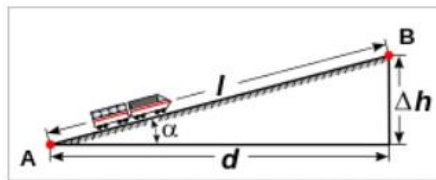

A vehicle on ascending gradient

- **Ruling gradient** is the design gradient, so it is used to design the road in the vertical alignment.
- **Limiting and exceptional gradients** are provided in the limited stretch of the roads where necessary and in case of the emergencies or exceptional cases when such need arises respectively.
- **Minimum gradient** is the gradient which is required as the minimum from the drainage point of view in case of the plane areas.

## Design speed:

The design speed, as noted earlier, is the single most important factor in the design of horizontal alignment. The design speed also depends on the type of the road. For e.g, the design speed expected from a National highway will be much higher than a village road, and hence the curve geometry will vary significantly. The design speed also depends on the type of terrain. A plain terrain can afford to have any geometry, but for the same standard in a hilly terrain requires substantial cutting and filling implying exorbitant costs as well as safety concern due to unstable slopes. Therefore, the design speed is normally reduced for terrains with steep slopes. For instance, Indian Road Congress (IRC) has classified the terrains into four categories, namely plain, rolling, mountainous, and steep based on the cross slope as given in table. Based on the type of road and type of terrain the

design speed varies. The IRC has suggested desirable or ruling speed as well as minimum suggested design speed and is tabulated in table :

### Table : Terrain classification

<b>Table : Terrain classification</b>	
Terrain classification	Cross slope (%)
Plain	0-10
Rolling	10-25
Mountainous	25-60
Steep	60

The recommended design speed is given in Table .

<b>Table : Design speed in as per IRC (ruling and minimum)</b>				
Type	Plain	Rolling	Hilly	Steep
NS&SH	100-80	80-65	50-40	40-30
MDR	80-65	65-50	40-30	30-20
ODR	65-50	50-40	30-25	25-20
VR	50-40	40-35	25-20	25-20

### Terrain classification Cross slope (%)

Plain	0-10
Rolling	10-25
Mountainous	25-60
Steep	60

The recommended design speed is given in Table .



**Table : Design speed in as per IRC (ruling and minimum)**

Type	Plain	Rolling	Hilly	Steep
NS&SH	100-80	80-65	50-40	40-30
MDR	80-65	65-50	40-30	30-20
ODR	65-50	50-40	30-25	25-20
VR	50-40	40-35	25-20	25-20

**1. Topography:**

The next important factor that affects the geometric design is the topography. It is easier to construct roads with required standards for a plain terrain. However, for a given design speed, the construction cost increases multiform with the gradient and the terrain. Therefore, geometric design standards are different for different terrain to keep the cost of construction and time of construction under control. This is characterized by sharper curves and steeper gradients.

**2. Other factors :**

In addition to design speed and topography, there are various other factors that affect the geometric design and they are briefly discussed below:

**Vehicle:** The dimensions, weight of the axle and operating characteristics of a vehicle influence the design aspects such as width of the pavement, radii of the curve, clearances, parking geometrics etc. A design vehicle which has standard weight, dimensions and operating characteristics are used to establish highway design controls to accommodate vehicles of a designated type.

**Human:** The important human factors that influence geometric design are the physical, mental and psychological characteristics of the driver and pedestrians like the reaction time.

**Traffic:** It will be uneconomical to design the road for peak traffic flow. Therefore a reasonable value of traffic volume is selected as the design hourly volume which is determined from the various traffic data collected. The geometric design is thus based on this design volume, capacity etc.

**Environmental:** Factors like air pollution, noise pollution etc. should be given due consideration in the geometric design of roads.

**Economy:** The design adopted should be economical as far as possible. It should match with the funds allotted for capital cost and maintenance cost.

**Others:** Geometric design should be such that the aesthetics of the region is not affected.

### **Average running speed**

Running speed is the average speed maintained over a particular course while the vehicle is moving and is found by dividing the length of the course by the time duration the vehicle was in motion. i.e. this speed doesn't consider the time during which the vehicle is brought to a stop, or has to wait till it has a clear road ahead. The running speed will always be more than or equal to the journey speed, as delays are not considered in calculating the running speed.

### **Sight Distances:**

The safe and efficient operation of vehicles on the road depends very much on the visibility of the road ahead of the driver. Thus the geometric design of the road should be done such that any obstruction on the road length could be visible to the driver from some distance ahead. This distance is said to be the sight distance.

### **Types of sight distance**

Sight distance available from a point is the actual distance along the road surface, over which a driver from a specified height above the carriage way has visibility of stationary or moving objects. Three sight distance situations are considered for design:

1. Stopping sight distance (SSD) or the absolute minimum sight distance
2. Intermediate sight distance (ISD) is defined as twice SSD
3. Overtaking sight distance (OSD) for safe overtaking operation
4. Head light sight distance is the distance visible to a driver during night driving under the illumination of head lights
5. Safe sight distance to enter into an intersection.

The most important consideration in all these is that at all times the driver travelling at the design speed of the highway must have sufficient carriageway distance within his line of vision to allow him to stop his vehicle before colliding with a slowly moving or stationary object appearing suddenly in his own traffic lane.

The computation of sight distance depends on:

#### **1. Reaction time of the driver**

Reaction time of a driver is the time taken from the instant the object is visible to the driver to the instant when the brakes are applied. The total reaction time may be split up into four components based on PIEV theory. In practice, all these times are usually combined into a total perception-reaction time suitable for design purposes as well as for easy measurement. Many of the studies shows that drivers require about 1.5 to 2 secs under normal conditions. However, taking into consideration the variability of driver characteristics, a higher value is normally used in design. For example, IRC suggests a reaction time of 2.5 secs.

#### **2. Speed of the vehicle**

The speed of the vehicle very much affects the sight distance. Higher the

speed, more time will be required to stop the vehicle. Hence it is evident that, as the speed increases, sight distance also increases.

### 3. Efficiency of brakes

The efficiency of the brakes depends upon the age of the vehicle, vehicle characteristics etc. If the brake efficiency is 100%, the vehicle will stop the moment the brakes are applied. But practically, it is not possible to achieve 100% brake efficiency. Therefore the sight distance required will be more when the efficiency of brakes are less. Also for safe geometric design, we assume that the vehicles have only 50% brake efficiency.

### 4. Frictional resistance between the tyre and the road

The frictional resistance between the tyre and road plays an important role to bring the vehicle to stop. When the frictional resistance is more, the vehicles stop immediately. Thus sight required will be less. No separate provision for brake efficiency is provided while computing the sight distance. This is taken into account along with the factor of longitudinal friction. IRC has specified the value of longitudinal friction in between 0.35 to 0.4.

### 5. Gradient of the road.

Gradient of the road also affects the sight distance. While climbing up a gradient, the vehicle can stop immediately. Therefore sight distance required is less. While descending a gradient, gravity also comes into action and more time will be required to stop the vehicle. Sight distance required will be more in this case.

### Stopping sight distance (SSD)

Stopping sight distance (SSD) is the minimum sight distance available on a highway at any spot having sufficient length to enable the driver to stop a vehicle travelling at design speed, safely without collision with any other obstruction.

There is a term called *safe stopping distance* and is one of the important measures in traffic engineering. It is the distance a vehicle travels from the point at which a situation is first perceived to the time the deceleration is complete. Drivers must have adequate time if they are to suddenly respond to a situation. Thus in highway design, sight distance at least equal to the safe stopping distance should be provided. The stopping sight distance is the sum of lag distance and the braking distance. Lag distance is the distance the vehicle travelled during the reaction time  $t$  and is given by  $vt$ , where  $v$  is the velocity in  $m/sec$ . Braking distance is the distance travelled by the vehicle during braking operation. For a level road this is obtained by equating the work done in stopping the vehicle and the kinetic energy of the vehicle. If  $F$  is the maximum frictional force developed and the braking distance is  $l$ , then work done against friction in stopping the vehicle is  $Fl = fWl$  where  $W$  is the total weight of the vehicle. The kinetic energy at the design speed is

$$\begin{aligned}\frac{1}{2}mv^2 &= \frac{1}{2} \frac{Wv^2}{g} \\ fWl &= \frac{Wv^2}{2g} \\ l &= \frac{v^2}{2gf}\end{aligned}$$

Therefore, the SSD = lag distance + braking distance and given by:

$$SSD = vt + \frac{v^2}{2gf}$$

where  $v$  is the design speed in  $m/sec^2$ ,  $t$  is the reaction time in  $sec$ ,  $g$  is the acceleration due to gravity and  $f$  is the coefficient of friction. The coefficient of friction  $f$  is given below for various design speed.

**Table 1:** Coefficient of longitudinal friction

Speed, kmph	<30	40	50	60	>80
$f$	0.40	0.38	0.37	0.36	0.35

When there is an ascending gradient of say  $+n\%$ , the component of gravity adds to braking action and hence braking distance is decreased. The component of gravity acting parallel to the surface which adds to the the braking force is equal to  $W \sin \alpha \approx W \tan \alpha = Wn/100$ . Equating kinetic energy and work done:

$$\begin{aligned}\left(fW + \frac{Wn}{100}\right)l &= \frac{Wv^2}{2g} \\ l &= \frac{v^2}{2g\left(f + \frac{n}{100}\right)}\end{aligned}$$

### Overtaking sight distance:

The overtaking sight distance is the minimum distance open to the vision of the driver of a vehicle intending to overtake the slow vehicle ahead safely against the traffic in the opposite direction. The overtaking sight distance or passing sight distance is measured along the centre line of the road over which a driver with his eye level 1.2 m above the road surface can see the top of an object 1.2 m above the road surface.

The factors that affect the OSD are:

1. Velocities of the overtaking vehicle, overtaken vehicle and of the vehicle

coming in the opposite direction.

2. Spacing between vehicles, which in-turn depends on the speed
3. Skill and reaction time of the driver
4. Rate of acceleration of overtaking vehicle
5. Gradient of the road

The dynamics of the overtaking operation is given in the figure which is a time-space diagram. The x-axis denotes the time and y-axis shows the distance travelled by the vehicles. The trajectory of the slow moving vehicle (B) is shown as a straight line which indicates that it is travelling at a constant speed. A fast moving vehicle (A) is travelling behind the vehicle B. The trajectory of the vehicle is shown initially with a steeper slope. The dotted line indicates the path of the vehicle A if B was absent. The vehicle A slows down to follow the vehicle B as shown in the figure with same slope from  $t_0$  to  $t_1$ . Then it overtakes the vehicle B and occupies the left lane at time  $t_3$ . The time duration  $T = t_3 - t_1$  is the actual duration of the overtaking operation. The snapshots of the road at time  $t_0, t_1$ , and  $t_3$  are shown on the left side of the figure. From the Figure 1, the overtaking sight distance consists of three parts.

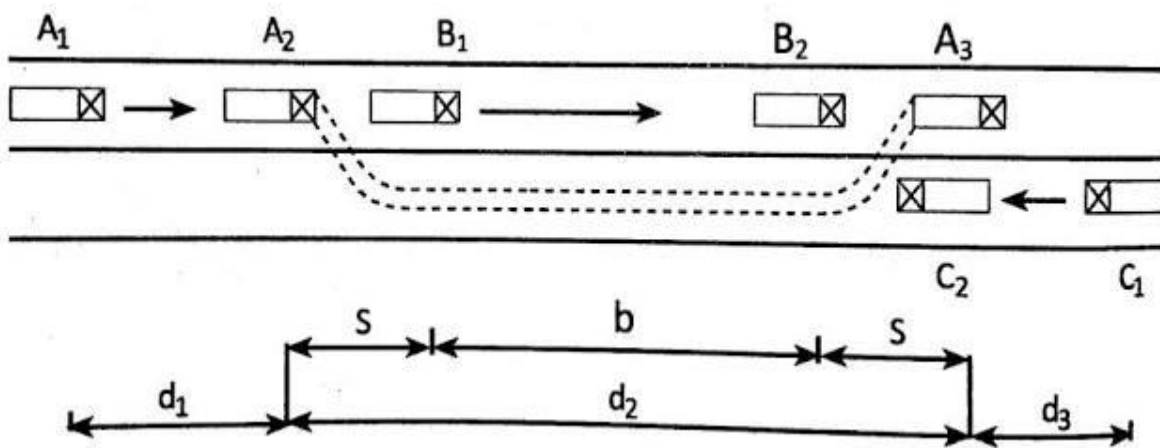

1.  $d_1$  the distance travelled by overtaking vehicle A during the reaction time  $t = t_1 - t_0$
2.  $d_2$  the distance travelled by the vehicle during the actual overtaking operation  $T = t_3 - t_1$
3.  $d_3$  is the distance travelled by on-coming vehicle C during the overtaking operation ( $T$ ).

Therefore:

$$OSD = d_1 + d_2 + d_3 \tag{3}$$

It is assumed that the vehicle A is forced to reduce its speed to  $v_b$ , the speed of the slow moving vehicle B and travels behind it during the reaction time  $t$  the driver. So  $d_1$  is given by:

$$d_1 = v_b t \tag{4}$$

Then the vehicle A starts to accelerate, shifts the lane, overtake and shift back to the

original lane. The vehicle A maintains the spacing  $s$  before and after overtaking. The spacing  $s$  in  $m$  is given by:

$$s = 0.7v_b + 6 \quad (5)$$

Let  $T$  be the duration of actual overtaking. The distance travelled by B during the overtaking operation is  $2s + v_bT$ . Also, during this time, vehicle A accelerated from initial velocity  $v_b$  and overtaking is completed while reaching final velocity  $v$ . Hence the distance travelled is given by:

$$\begin{aligned} d_2 &= v_bT + \frac{1}{2}aT^2 \\ 2s + v_bT &= v_bT + \frac{1}{2}aT^2 \\ 2s &= \frac{1}{2}aT^2 \\ T &= \sqrt{\frac{4s}{a}} \\ d_2 &= 2s + v_b\sqrt{\frac{4s}{a}} \end{aligned} \quad (6)$$

The distance travelled by the vehicle C moving at design speed  $v$   $m/sec$  during overtaking operation is given by:

$$d_3 = vT \quad (7)$$

The overtaking sight distance is:

$$OSD = v_b t + 2s + v_b\sqrt{\frac{4s}{a}} + vT$$

where  $v_b$  is the velocity of the slow moving vehicle in  $m/sec^2$ ,  $t$  the reaction time of the driver in  $sec$ ,  $s$  is the spacing between the two vehicle in  $m$  given by equation 5 and  $a$  is the overtaking vehicles acceleration in  $m/sec^2$ . In case the speed of the overtaken vehicle is not given, it can be assumed that it moves 16 kmph slower the design speed.

The acceleration values of the fast vehicle depends on its speed and given in Table .

**Table :** Maximum overtaking acceleration at different speeds:

Speed (kmph)	Maximum overtaking acceleration ( $m/sec^2$ )
25	1.41
30	1.30
40	1.24
50	1.11

Note that:

1. On divided highways,  $d_3$  need not be considered
2. On divided highways with four or more lanes, IRC suggests that it is not necessary to provide the OSD, but only SSD is sufficient.

### Overtaking zones

Overtaking zones are provided when OSD cannot be provided throughout the length of the highway. These are zones dedicated for overtaking operation, marked with wide roads. The desirable length of overtaking zones is 5 times OSD and the minimum is three times OSD (Figure ).

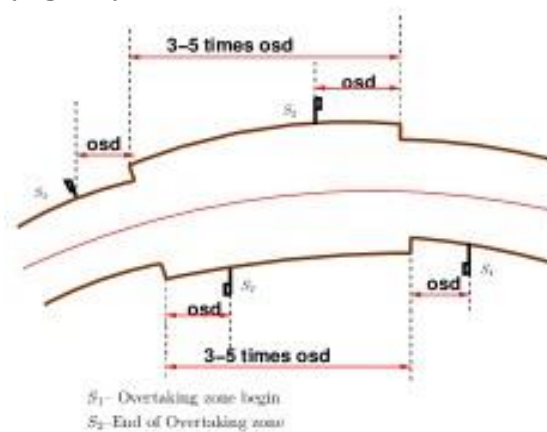

**Figure :** Overtaking zones

### Sight distance at intersections

At intersections where two or more roads meet, visibility should be provided for the drivers approaching the intersection from either sides. They should be able to

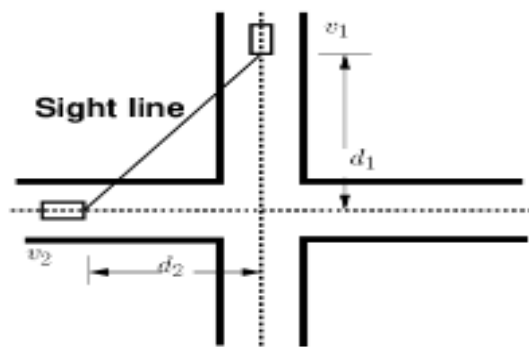

perceive a hazard and stop the vehicle if required. Stopping sight distance for each road can be computed from the design speed. The sight distance should be provided such that the drivers on either side should be able to see each other. This is illustrated in the figure . **Figure : Sight distance at intersections**

Design of sight distance at intersections may be used on three possible conditions:

1. Enabling approaching vehicle to change the speed
2. Enabling approaching vehicle to stop
3. Enabling stopped vehicle to cross a main road

## **CURVES**

### **Definition of Curves:**

Curves are regular bends provided in the lines of communication like roads, railways etc. and also in canals to bring about the gradual change of direction.

They are also used in the vertical plane at all changes of grade to avoid the abrupt change of grade at the apex.

Curves provided in the horizontal plane to have the gradual change in direction are known as Horizontal curves, whereas those provided in the vertical plane to obtain the gradual change in grade are known as vertical curves. Curves are laid out on the ground along the centre line of the work. They may be circular or parabolic.

### **Types of Curves:**

The amount of rise seen on a given cross-section of a turning road, it is otherwise known as slope.

### **Vertical Curves**

Vertical curves are provided to change the slope in the road and may or may not be symmetrical. They are parabolic and not circular like horizontal curves. Identifying the proper grade and the safe passing sight distance is the main design criterion of the vertical curve, crest vertical curve the length should be enough to provide safe stopping sight distance and in sag vertical curve the length is important as it influences the factors such as headlight sight distance, rider comfort and drainage requirements.

### **Types of Vertical Curve:**

#### **Sag Curve**

Sag Curves are those which change the alignment of the road from uphill to downhill,

#### **Crest Curve/Summit Curve**

Crest Curves are those which change the alignment of the road from downhill to uphill. In designing crest vertical curves it is important that the grades be not too high which makes it difficult for the motorists to travel upon it.

### **Super elevation :**

When a vehicle travels in a circular path or curved path, it is subjected to an outward force



which makes a vehicle to overturn and skid due to Centrifugal force. To overcome this force and for safe travel of a vehicle, the outer edge of the road is raised above the inner edge. This is known as super elevation.

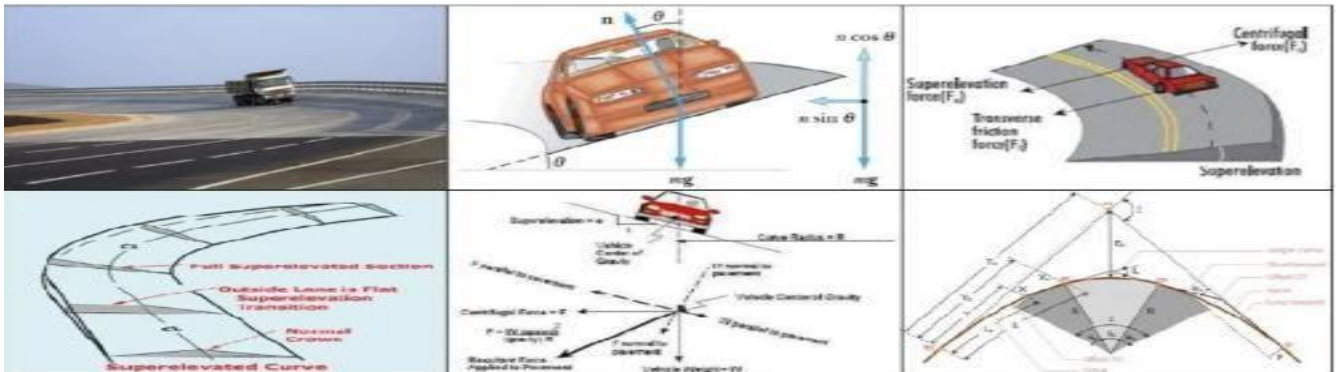

**Super-Elevation / Banking of road** reduces the effect of centrifugal force on the running wheels. If super-elevation is not provided with the entire centripetal.

force is produced by the friction between the vehicle's tires and the roadway, thus results in reducing the speed of a vehicle.

**Advantages of providing Super elevation:-**

1. Super elevation is provided to achieve the higher speed of vehicles. It increases the stability of fast-moving vehicles when they pass through a horizontal curve, and it also decreases the stresses on the foundation.
2. In the absence of super elevation on the road along curves, potholes are likely to occur at the outer edge of the road.
3. The Indian road congress (IRC) has prescribed the max value of Super Elevation is 1 in 15.

### **Derivation of Super Elevation:**

When a vehicle passes from a straight to a curved path or in other words when a vehicle negotiates horizontal curve following two forces act on vehicle.

1. Centrifugal Force
2. Weight of the Vehicle

Thus super-elevation  $e$  is the ratio of the height of the outer edge with respect to the horizontal width.

**Centrifugal Force** - The centrifugal force is a function of the speed of the moving vehicle. It always acts at the centre of gravity of the vehicle. It's direction always tends to outside, i.e., it always tends to push the vehicle out of the track. To counteract this tendency, the outer edge of the road is raised above the inner edge. **This rise of the outer edge is called super-elevation or cant or banking.**

$$e = \tan \theta$$

In practice, the value of  $\theta$  is kept as  $4^\circ$  or a slope of 1 in 15 with horizontal.  
The total height of the outer edge with respect to the inner edge:

$$E = e \times \text{width of road} \\ = e B$$

The centrifugal force  $P = Wv^2/gR$

Where,

$W$  = weight of the vehicle

$v$  = velocity of the vehicle

$R$  = radius of circular curve

$P$  = centrifugal force

$g$  = acceleration due to gravity

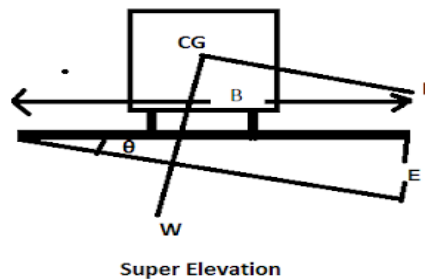

### 1. Effect of Centrifugal Force

1. The tendency to overturn the vehicle.
2. The tendency to skid the vehicle laterally.

### Stability Condition Against Overturning

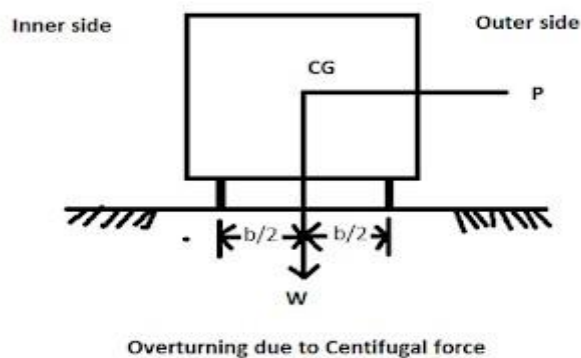

The figure shows a vehicle moving on horizontal a curve. Forces acting on the vehicle are

- Centrifugal force  $P$  acting outward at C.G.
- Weight  $W$  acting downward at C.G.

Let  $h$  be the height of C.G. of the vehicle above the road level. The overturning moment due to centrifugal force.

$$= P \times h$$

The restoring moment  $= W \times b/2$

where  $b$  is the centre to centre distance of wheels of the vehicle.

in limiting equilibrium

$$Ph = Wb/2$$

$$P/W = b/2h$$

When the centrifugal ratio,  $P/W$  is equal to  $B/2h$  there is a danger of overturning. Thus to avoid overturning, the centrifugal ratio should always be less than  $b/2h$ .

$$P/W = v^2/Gr$$

$$v^2/gR < b/2h$$

Thus to avoid overturning  $h$  should be as small as possible. Only due to this reason modern passenger cars have a low centre of gravity.

## Stability Condition Against Skidding

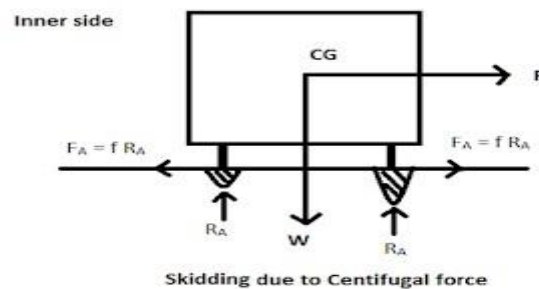

The lateral thrust  $P = Wv^2/gR$  is resisted by the frictional force between the tyre and pavement surface. If the lateral resisting friction is less than the centrifugal force  $P$ , then skid will occur. Thus in limiting equilibrium,  $P =$  Maximum lateral friction developed as shown in the figure.

$$P = F_a + F_b$$

or  $P = f (R_A + R_B)$

=  $fW$

Or  $P/W = f$

Thus when the centrifugal ratio attains the value equal to the lateral coefficient of friction, there is a danger of lateral skidding.

If  $f < b/2h$  skidding would occur.

If  $f > B/2h$  overturning at the outer edge would occur.

### Methods of providing super-elevation :

Super-elevation is designed for the particular vehicle called design vehicle which has some standard weight and dimensions. But in the actual case, the road has mixed traffic conditions. Different vehicles require different values of super-elevation. For example Heavily loaded trucks require the small value of super-elevation otherwise toppling may occur, fast moving vehicles may be provided with high super-elevation while slow moving ones require small super-elevation. The design procedure for super-elevation is as follows:

**Step 1** Find value of super-elevation taking 75% of design speed neglecting  $f$ ,

$$\text{Hence, } e = (0.75v)^2 / (g \cdot R)$$

**Step 2** If value of  $e$  is less than 0.07 then it is taken for design otherwise value of  $e$  is taken as 0.07.

**Step 3** Find value of frictional coefficient ( $f$ ) with full design speed regarding maximum super-elevation.

$$\text{Hence, } f = v^2 / (g \cdot R) - e = v^2 / (g \cdot R) - 0.07$$

**Step 4** If value for  $f$  is less than 0.15 then it is taken for design otherwise value for  $f$  is taken as 0.15.

**Step 5** The allowable speed for maximum value of  $e = 0.07$  and  $f = 0.15$  is calculated

$$\text{Hence, Allowable speed } (V_a) = \sqrt{(0.22g \cdot R)}$$

If the allowable velocity is greater than or equal to  $v$  then the design is adequate otherwise other speed control measures are adopted.

Different guidelines are given in NRS for the design of horizontal curvature. In terms of velocity in kmph it is calculated as,

$$\text{Or, } V^2 / (126.5 \cdot R) = e + f$$

$$\text{And, } V_a = \sqrt{[126.5 \cdot R \cdot (e + f)]}$$

### Methods of introducing superelevation:

Superelevation is introduced in two ways usually

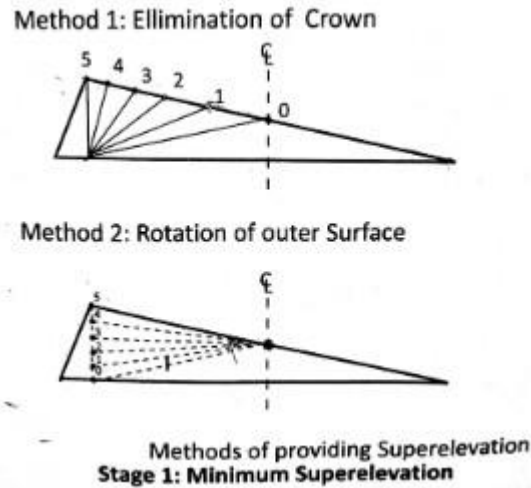

### 1. Elimination of the crown of the cambered section

- The outer edge half of the cross slopes is rotated about the crown at the desired rate such that its surface falls on the same plane as the inner half.
- The position of the crown is progressively shifted outwards which increases the width of the inner half of the cross-section progressively. It is also called as the diagonal crown method.

### 2. Rotation of the pavement cross section to attain full superelevation

- Rotation about the center line: It is mostly preferred by the majority of designers. This method involves progressively revolving the straight road surface about the center line depressing the inner edge and raising the outer edge simultaneously by an amount of half the total amount of superelevation. Thus the earthwork is the balanced i.e. volume of cutting and filling required in this method will be equal. Due to depressing inner edge below general level, the disadvantage of this method is drainage.
- Rotation about the inner edge: This method involves progressively revolving the straight road surface about the inner edge thereby raising the center line and the outer edge proportionately to the desired slope. Here the outer edge is raised by the full amount of superelevation. This method is preferred in very flat terrain in high rainfall areas in order to avoid drainage problem. The rise of the center line is considered a disadvantage in this method since the vertical alignment of the road is altered.
- Rotation about the outer edge: This method involves progressively revolving the straight road surface about the outer edge thereby depressing the center line and the outer edge proportionately to the desired slope. Here the inner edge is depressed by the full amount of superelevation with respect to the outer edge. This method is similar to the rotation about the inner edge.

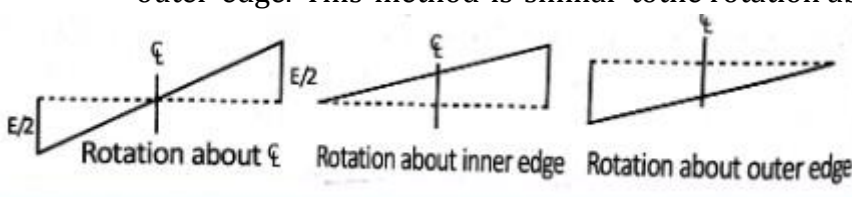

### **EXTRA WIDENING**

On a horizontal curve especially when there are not many very large radius, it is common to widen the pavement or carriageway slightly more than the normal width. This additional increase in the width of the pavement is termed as extra widening. The reasons of providing extra widening are given below:

1. Due to the rigidity of rear wheel base of the vehicle moving along the curve they don't trace the same path as taken by the front steering wheels. This is called off tracking. During this case, mechanical widening is required.
2. Due to the psychological tendency of drivers, drivers tend to take the outer lane for greater visibility and easy gradient at the beginning of the curves. So extra width is provided.
3. Drivers have the tendency to keep greater clearance between opposite vehicles on curves when road visibility is inadequate.
4. Drivers have the tendency to keep away from the edge of the carriageway while driving on curves.
5. When traveling in a curved path more space is occupied by the vehicles during turning.
6. Trailer units require even larger extra width at curves.
7. At speeds higher than the design speed outward slipping of the rear wheel may occur due to centrifugal force and thus more width of the road is covered. Even in lower speeds, the front tires tend to go out of the pavement and thus extra widening is required.
8. The extra width is provided to ensure safe and efficient overtaking operations.
9. The amount of extra widening required depends on the following factors:
  1. Length of the wheel base of the vehicle
  2. Psychological factor
  3. Radius of the curve

The analysis of extra widening is done in two parts namely:

1. Mechanical widening
2. Psychological widening

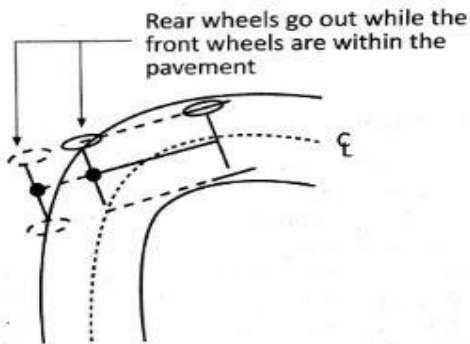

(a) Off-tracking

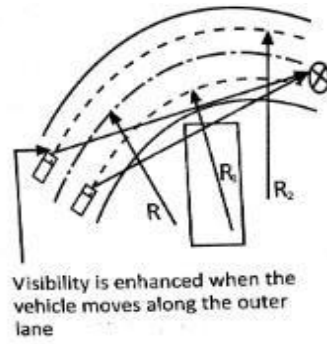

(b) Preferential use of outer lane

## Mechanical widening

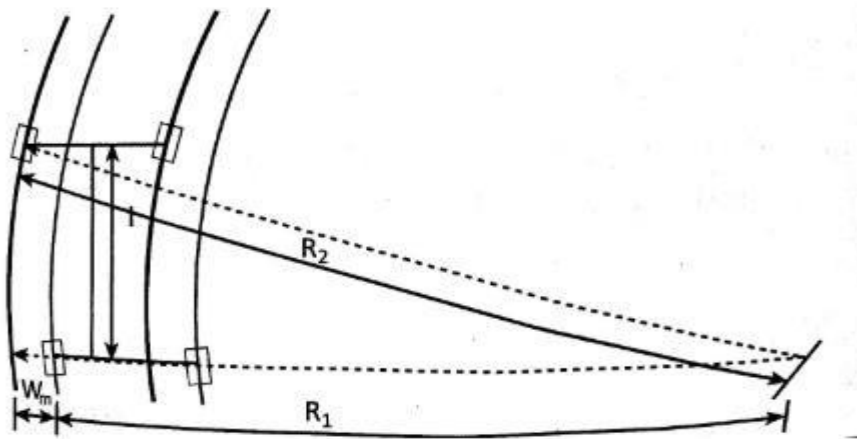

It is the amount of the extra width required to account for the off tracking of the vehicle due to the rigidity of the rear wheel base. Due to off tracking, the rear wheels follow a path of shorter radius than the front ones and thus it increases the effective width of road space required by the vehicle. So we provide extra width to provide same clearance between vehicles, to provide safety against transverse skidding during high speeds and also to provide stability for vehicles like trailer trucks. Thus it is an important factor during operation of high proportions of vehicles.

Let  $R_1$  be the radius of the path travelled by the outer track line of the rear wheel,  $R_2$  be the radius of the path travelled by the outer track line of the front wheel and  $l$  be the distance between the front and rear wheels. Then the mechanical widening is given by:

$$W_m = R_2 - R_1$$

$$\text{Or, } R_1 = R_2 - W_m$$

From the triangle, we can say that

$$R_2^2 = R_1^2 + l^2$$

$$\text{Or, } R_2^2 = (R_2 - W_m)^2 + l^2$$

$$\text{Or, } R_2^2 = R_2^2 - 2 \cdot R_2 \cdot W_m + W_m^2 + l^2$$

$$\text{Or, } l^2 = 2 \cdot R_2 \cdot W_m - W_m^2$$

Hence the widening required will be,

$$W_m = l^2 / (2 \cdot R^2 - W_m)$$

For large radius  $R_1 \approx R_2$  which is the mean radius of the curve,  $W_m$  becomes very small in comparison to  $R$  then the mechanical widening is given by:

$$W_m = \frac{l^2}{2 \cdot R} \quad \text{For } n$$

number of lanes,

$$W_m = \frac{(n \cdot l^2)}{2 \cdot R}$$

## 1. Psychological widening

It is the amount of additional width required due to various psychological reasons i.e. for greater maneuverability, for confidence, for the tendency to maintain greater clearance between vehicles, for the tendency of drivers to drive close to the edges of the pavement on curves, etc. which the driver will be needing is termed as psychological widening. It is very difficult to assess so IRC has proposed an empirical relation for the psychological widening.

$$W_{psy} = v / (2.64 \cdot \sqrt{R})$$

Where,  $W_{psy}$  is the psychological widening,  $v$  is the velocity in m/s and  $R$  is the radius in meter.

In terms of kmph,

$$W_{psy} = v / (9.5 \cdot \sqrt{R})$$

Therefore the total widening required at a horizontal curve is,

$$W_e = W_m + W_{psy} = \frac{(n \cdot l^2)}{2 \cdot R} + v / (9.5 \cdot \sqrt{R})$$

Where,  $v$  is in kmph.

## Definition and Types of Vertical Curves:

The curve in a vertical alignment which is produced when two different gradients meet is known as vertical curves. It is provided to secure safety, safety, appearance and visibility. The most common practice has been to use parabolic curves in summit curves. This is because of the ease of setting it out on the field and the comfortable transition from one gradient to another. Furthermore, the use of parabolic curves gives excellent riding comfort. In the case of valley curves, the use of cubic parabola is preferred as it closely approximates the ideal transition requirements.

## Types of vertical curves

Depending upon the shape of profile, a vertical curve may be divided into:

1. **Summit curve:** When two grades meet at the summit and the curve will have convexity upwards, the curve is simply referred as summit curve.



2. **Valley (Sag) curve:** When two grades meet at the valley (sag) and the curve will have convexity downwards, the curve is simply referred as the valley (sag) curve.

### **Elements of vertical curve**

The different elements of vertical curve are:

1. Deviation angle (N) =  $n_1 - n_2$
2. Tangent length (T) =  $L/2$
3. Length of the curve (L) =  $2*T = N*R$
4. Apex distance (E) =  $\pm T^2 / (2*R) = \pm L^2 / (8*R)$
5. Mid-ordinate (M) =  $R [1 - \cos \{(180*N) / (2*\pi)\}]$
6. Where, n is the side gradient and R is the radius of the curve.

### **Design of Vertical Summit Curve**

Summit curves are those curves which have convexity upwards. They are formed under the four following conditions:

1. When a positive gradient meets another mild positive gradient
2. When a positive gradient meets a level zero gradient
3. When a positive gradient meets with a negative gradient
4. When a negative gradient meets another steeper negative gradient

During the design of vertical summit curve the comfort, appearance, and security of the driver should be considered. The sight distance must be considered in the design. All the types of sight distance should be considered during design as far as possible. During movement in a summit curve, there is less discomfort to the passengers because the centrifugal force developed by the movement of the vehicle on a summit curve act upwards which is opposite to the direction in which its weight acts. This relieves the load on the springs of the vehicle so stress developed will be less.

A simple parabolic curve is preferred in summit curve due to its easy implementation in the field, good riding comfort during driving and easy computation. The important part in summit curve design is the computation of the length of the summit curve which is done considering the sight distance parameters as shown below:

Two cases may arise during the design,

#### **1.LENGTH OF SUMMIT CURVE IS GREATER THAN THE SIGHT DISTANCE**

The equation of the parabolic curve is,

$$\text{Or, } y = a*x^2$$

$$\text{Where, } a = N / (2*L)$$

From figure,

Heights ( $h_1$ ) =  $as_1^2$  and  $h_2 = as_2^2$

Then,  $s_1 + s_2 = \sqrt{h_1 / a} + \sqrt{h_2 / a}$

Or,  $s_2 = (1/a) (\sqrt{h_1} + \sqrt{h_2})^2$

Or,  $s_2 = (2*L) * (\sqrt{h_1} + \sqrt{h_2})^2 / N$

Therefore,  $L = (NS^2) / [2 * (\sqrt{h_1} + \sqrt{h_2})^2]$

Where L is the length of the summit curve, s is the sight distance, N is the deviation angle,  $h_1$  is the height of the driver's eye from the road surface,  $h_2$  is the height of obstruction from the road surface.

In terms of stopping sight distance (SSD),

Height  $h_1 = 1.2\text{m}$  and  $h_2 = 0.15\text{m}$

Substituting we get,

$$L = Ns^2 / 4.4$$

- In terms of overtaking sight distance (OSD) and intermediate sight distance (ISD),

Height  $h_1 = 1.2\text{m}$  and  $h_2 = 1.2\text{m}$

Substituting we get,

$$L = Ns^2 / 9.6$$

## 2.LENGTH OF SUMMIT CURVE IS LESS THAN THE SIGHT DISTANCE

From basic geometry, one can write,

Or,  $s = L/2 + h_1/n_1 + h_2/n_2$

Or,  $s = L/2 + h_1/n_1 + h_2 / (N - n_1)$

For minimum value of s we differentiate the equation with respect to  $n_1$  and set it to zero,

Or,  $ds/dh_1 = -h_1/n_1^2 + h_2 / (N - n_1)^2 = 0$

Or,  $h_2n_1^2 = h_1 * (N^2 + n_1^2 - 2*N*n_1)$

Solving the equation we get,

Therefore,  $n_1 = (N * \sqrt{(h_1h_2)} - Nh_1) / (h_2 - h_1)$

Substituting value of  $n_1$  in s we get,

Or,  $s = L/2 + h_1 / (N * \sqrt{(h_1h_2)} - Nh_1) / (h_2 - h_1) + h_2 / [N - (N * \sqrt{(h_1h_2)} - Nh_1) / (h_2 - h_1)]$

Solving for L we get,

$$L = 2s - [\sqrt{(2h_1)} + \sqrt{(2h_2)}]^2 / N$$

- In terms of stopping sight distance (SSD),

Height  $h_1 = 1.2\text{m}$  and  $h_2 = 0.15\text{m}$

Substituting we get,

$$L = 2s - 4.4/N$$

In terms of overtaking sight distance (OSD) and intermediate sight distance (ISD),

Height  $h_1 = 1.2\text{m}$  and  $h_2 = 1.2\text{m}$

Substituting we get,

$$L = 2s - 9.6/N$$

It should be known that these values are the minimum lengths and greater sight distances should be used where there is economically and technically feasible.

### **Design of vertical valley curve**

1. When a negative gradient meets another mild negative gradient
2. When a negative gradient meets a level zero gradient
3. When a negative gradient meets with a positive gradient
4. When a positive gradient meets another steeper positive gradient

As compared to the design of summit curve, valley curve requires more consideration. During day time the visibility in valley curves are not hindered but during night time the only source of visibility becomes headlight in the absence of street lights. And in valley curves, the centrifugal force generated by the vehicle moving along a valley curve acts downwards along with the weight of the vehicle and this adds to the stress induced in the spring of the vehicle which causes jerking of the vehicle and discomfort to the passengers. Thus, the most important things to consider during valley curve design are:

- Impact and jerking free movement of vehicles at design speed
- Availability of stopping sight distance under headlight of vehicles during night driving

The best shape for a valley curve is transition curve. Some prefer to use the circular curve or quadratic parabola or combined circular spiral curve but mostly cubic parabola is generally preferred in vertical valley curves. Valley curve is made fully translational by providing two similar transition curves of equal length. It is set by cubic parabola  $y = bx^3$  where  $b = 2N / 3L^2$ . The length of the valley transition curve is designed to the following two criteria:

### **COMFORT CRITERIA**

This is used in design to provide impact-free movement of vehicles at design speed. In this criterion, the allowable rate of change of centrifugal acceleration ( $c$ ) is limited to a comfortable level of  $0.6\text{m/s}^3$ . The rate of change of centrifugal acceleration is given by,

$$\text{Or, } c = \left[ \frac{v^2}{R} - 0 \right] / t = \frac{v^2}{R} / \left( \frac{L_s}{v} \right)$$

$$\text{Then, } L_s = \frac{v^3}{c \cdot R}$$

For a cubic parabola, the value of  $R$  is given by,

$$R = L_s / N$$

Substituting value of  $R$  we get,

$$L_s = \frac{N \cdot v^3}{c \cdot L_s}$$

$$\text{Or, } L_s^2 = \frac{N \cdot v^3}{c}$$

$$\text{Therefore, } L_s = \sqrt{\left[ \frac{N \cdot v^3}{c} \right]}$$

The total length of the valley curve is given by,

$$L = 2 \cdot L_s = 2 \cdot \sqrt{\left[ \frac{N \cdot v^3}{c} \right]}$$

Where,  $L$  is the total length of the valley curve,  $N$  is the deviation angle,  $v$  is the design speed and  $c$  is the rate of change of centrifugal acceleration which may be taken as  $0.6\text{ m/s}^3$ .

Applying value of  $c = 0.6\text{ m/s}^3$  we get,

$$L_s = 0.19 \sqrt{N \cdot v^3}$$

$$L = 0.38 \sqrt{N \cdot v^3}$$

## **SAFETY CRITERIA**

Sight distance is highly reduced during headlight driving conditions during night time. The sight distance within which the head lights can illuminate is known as head light distance and it should be equal to the stopping sight distance. There is no problem of overtaking operation at night because of low traffic and the fact that other vehicles with headlights can be seen from a considerable distance. This design provides adequate stopping sight distance for vehicles under headlight at night time at any part of the curve. It may be determined from two conditions:

- **Length of the valley curve is greater than the stopping sight distance**

At the lowest point of the valley curve, the sight distance will be minimum because at the bottom of the curve where there is minimum radius which is a property of the transition curve. From the geometry of the figure, we have,

$$\text{Or, } h_1 + s \tan \alpha = as^2$$

$$\text{Where, } a = N / (2L)$$

$$\text{Then, } h_1 + s \tan \alpha = Ns^2 / (2L)$$

Therefore,

$$L = (Ns^2) / (2h_1 + 2s \tan \alpha)$$

Where N is the deviation angle, s is the sight distance, h<sub>1</sub> is the height of the headlight beam from the road surface and  $\alpha$  is the head beam inclination in degrees.

Taking, h<sub>1</sub> = 0.75m [NRS] and  $\alpha \approx 1^\circ 5'$  we get,

$$L = (Ns^2) / (1.5 + 0.035s)$$

- **Length of the valley curve is less than the stopping sight distance**

- In this case, the minimum sight distance will be at the beginning of the curve because the headlight beam at the beginning of the curve will just hit outside of the curve. But at the bottom of the curve, the headlight beam will reach far beyond the end point of the curve. Hence the length of the curve is determined to assume that the vehicle is at the beginning of the curve. From the geometry of the figure, we have,

- Or,  $h_1 + s \tan \alpha = (s - L/2) * N$

- Therefore,

- $L = 2*s - (2h_1 + 2s \tan \alpha) / N$

Where N is the deviation angle, s is the sight distance, h<sub>1</sub> is the height of the headlight beam from the road surface and  $\alpha$  is the head beam inclination in degrees.

Taking, h<sub>1</sub> = 0.75m [NRS] and  $\alpha \approx 1^\circ 5'$  we get,

$$L = 2*s - (1.5 + 0.035s) / N$$

The expression above is approximate but it is satisfactory in practice because the gradients are very small. During design, both cases need to be calculated because we will not know prior which case has to be adopted. After calculation, we adopt the greater length among the two during design.

According to the specification of NRS 2045, the criteria to be adopted are that the stopping sight distance shall be equal to the headlight sight distance and the centripetal acceleration is limited to  $0.3 \text{ m/s}^2$ .

### **Lowest and highest point of vertical curve**

From the element of a vertical curve, we can write,

$$\text{Length of a curve (L)} = R * N$$

Where, R is the radius of the curve and N is the deviation angle.

$$\text{Then, } R = L / N$$

The highest point is calculated in a summit curve whereas the lowest is calculated in a valley curve. It is formed near the smaller gradient among the tangents. If  $n_1 = +2\%$  and  $n_2 = -1.5\%$  then summit curve is formed where the highest point is formed near the  $n_2$  grade i.e. near the end of the vertical curve (EVC).

$$\text{Then, the distance of highest point from beginning of the curve (x1)} = R * n_1 = (L * n_1) / N$$

$$\text{Similarly from end of the curve (x2)} = R * n_2 = (L * n_2) / N$$

And tangent correction for the curve or the height of the highest point of the curve is given by,

$$\text{Or, } y = x^2 / (2 * R) = (N * x^2) / (2 * L)$$

The lowest point of the curve is calculated in the same manner in the case of valley curve.

In the case of valley curve, if the curve is cubic parabola then the lowest point of the valley curve lies on the side of the flatter grade and the distance of the lowest point from the flatter gradient is given by:

$$\text{Or, } x_1 = L * \sqrt{[n_1 / (2 * N)]}$$

$$\text{And, tangent correction (y)} = (x^3 * 2N) / (3 * L^2)$$

### **UNIT 3-ROAD MATERIALS**

A wide variety of materials are used in the construction of roads these are soils (naturally occurring or processed), aggregates (fine aggregates or coarse aggregates obtained from rocks), binders like lime, bituminous materials, and cement, and miscellaneous materials used as admixtures for improved performance of roads under heavy loads and traffic.

Soil constitutes the primary material for the foundation, subgrade, or even the pavement (for low-cost roads with low traffic in rural areas). When the highway is constructed on an embankment at the desired level, soil constitutes the primary embankment material; further, since all structures have to ultimately rest on and transmit loads to 'mother earth', soil and rock also serve as foundation materials.

Soil is invariably used after some process of stabilization such as compaction and strengthening by adding suitable admixtures for improving the performance of the road. Mineral aggregates obtained from rocks form the major component of the sub-bases and bases of highway pavements of almost all types.

#### **1.Soil**

1. Soils can be studied effectively if they are classified according to certain principles into a definite system. A system is an ordered grouping of certain elements in a discipline according to pre-defined principles. Just as classification or grouping is practised in scientific disciplines such as chemistry, zoology and botany, it is used in Geotechnical Engineering as well.
2. A soil classification system may be defined as a fundamental division of the various types of soil into groups according to certain parameters such as its physical properties, constituents or texture, field performance under load,

presence of water and so on. There are a few field identification tests have been developed for preliminary identification in the field.

### **Need for Soil Classification:**

Soil deposits in nature are never homogenous in character; wide variations are observed in their properties and behaviour. Soils that exhibit similar average properties may be grouped as a class. Classification of soil is necessary to obtain an appropriate and fairly accurate idea of the properties and behaviour of a soil type.

A classification system is usually evolved with a view to assessing the suitability of a soil for specific use as a construction material or as a foundation material. In view of the wide variations in engineering properties of several soils, it is inevitable that in any system of classification, there will be borderline cases which may fall into groups that appear to be radically different under different systems of classification.

Hence, classification is taken only as a preliminary requirement to study the engineering behaviour of a soil; special tests may become necessary in any project of importance.

### **Requirements of a Soil Classification System:**

#### **The general requirements of an ideal soil classification system are:**

- i. It should have a scientific basis.
- ii. It should be relatively simple and objective in approach.
- iii. The number of groupings and properties used as the criteria should be limited.
- iv. The properties considered should be relevant to the purpose of classification.
- v. A generally accepted uniform soil terminology should be used.
- vi. It should indicate the probable performance of the soil to a satisfactory degree of accuracy.
- vii. Group boundaries should be drawn as closely as possible where significant changes in soil properties occur.
- viii. It should be acceptable to all engineers.

Although several classification systems have been developed, some being relatively more elaborate and exhaustive than others, the following systems only will be considered:

- (a) Textural classification
- (b) PRA system of classification (Group index method)
- (c) Unified soil classification System
- (d) Indian Standard Soil classification system

## **2. Stone Aggregates:**

Stone aggregate, or mineral aggregate, as it is called, is the most important component of the materials used in the construction of roads. These aggregates are derived from rocks, which are formed by the cementation of minerals by the forces of nature.

Stone aggregates are invariably derived by breaking the naturally occurring rocks

to the required sizes. They are used for granular bases, sub-bases, as part of bituminous mixes and cement concrete; they are also the primary component of a relatively cheaper road, called water-bound macadam.

A study of the types of aggregates, their properties, and the tests to determine their suitability for a specific purpose is of utmost importance to a highway engineer. Properties such as strength and durability of aggregates are generally influenced by their origin of occurrence, mineral constituents and the nature of the bond between the constituents.

### **Geological Classification of Rocks:**

**Geologically speaking, rocks are classified into the following categories:**

#### **(a) Igneous Rocks:**

These are formed by the cooling, solidification and crystallisation of molten rock on the earth's crust at different depths. The minerals, their proportions and the rate of cooling of the magma have a bearing on the strength characteristics of the rock.

Igneous rocks are, in general, stronger than the other two types. Granite, diorite and gabbro are intrusive rocks which form at deep layers in the earth's crust.

Basalt (or trap), andesite, rhyolite and dolerite are extrusive rocks which form at the top layers of the earth's crust.

#### **(b) Sedimentary Rocks:**

Fine material or rock fragments and particles transported by water or wind and deposited in layers, get hardened in course of time to form sedimentary rocks (the time required is on geologic scale). They consist of a layered structure; the rock beds are stratified, they may be porous, and have relatively low strength.

Examples of siliceous variety are sandstone and argillite; those of calcareous variety are limestone and dolomite.

#### **(c) Metamorphic Rocks:**

These are formed by the modification and re-crystallisation of igneous rocks and sedimentary rocks by geological and natural agents such as temperature, pressure, moisture, humidity, and movement of rock beds.

Major changes occur in geologic time and form foliations. This kind of foliated structure makes these rocks comparably weaker than igneous rocks. Popular examples of metamorphic rocks are gneiss (from granite), slate (from shale) and schist.

Examples of un-foliated types are marble (from limestone) and quartzite (from sandstone). (Marble and gneiss are used for flooring and face work in buildings.)

### **Desirable Properties of Sand Aggregates:**

The following properties are desirable in soil aggregates used in the construction of roads:

#### **(i) Strength:**

It is the resistance to crushing which the aggregates used in road construction, especially in the top layers and wearing course, have to withstand the stresses due to wheel loads of the traffic in addition to wear and tear.

#### **(ii) Hardness:**



It is the resistance to abrasion of the aggregate at the surface. The constant rubbing or abrading action between the tyres of moving vehicles and the exposed aggregate at the road surface should be resisted adequately.

**(iii) Toughness:**

This is the resistance to impact due to moving traffic. Heavily loaded trucks and other vehicles cause heavy impact loads on the road surface while moving at high speeds, and while accelerating and decelerating. Even steel-tired vehicles, though moving slow, cause heavy impact on the aggregates exposed at the surface. Hence, resistance to such impact forces is a desirable quality.

**(iv) Durability:**

It is the resistance to the process of disintegration due to the weathering action of the forces of nature. The property by virtue of which the aggregate withstands weathering is called soundness. This is also a desirable property.

**(v) Cementation:**

It is the ability of the aggregate to form its own binding material under traffic, providing resistance to lateral displacement. Limestone and laterite are examples of stones with good cementing quality. This becomes important in the case of water-bound macadam roads.

**(vi) Appropriate Shape:**

Aggregates may be either rounded, cubical, angular, flaky, or elongated. Each shape is appropriate for a certain use. Too flaky and too elongated aggregates have less strength and durability; so they are not preferred in road construction. Rounded aggregates are good for cement concrete because of the workability such aggregates provide. Cubical or angular aggregates have good interlocking properties; since flexible pavements derive their stability due to interlocking, such aggregates are the preferred type for construction. Thus, the appropriate shape for a particular use is also a desirable property.

**(vii) Adhesion with Bitumen:**

The aggregates used in bituminous pavements should have less affinity to water than to bitumen; otherwise, the bituminous coating on the surface of the aggregate will get stripped off in the presence of water. So, hydrophobic characteristic is a desirable property for aggregates to be used in the construction of bituminous roads.

**(viii) Attrition:**

This is mutual rubbing of aggregates under traffic; adequate resistance to attrition is a desirable property.

**(ix) Texture:**

This is a measure of the degree of fineness or smoothness of the surface of the aggregate. Gravels from river beds are fairly smooth; as a rule, fine grained rock is highly resistant to wear and is preferred for surface courses.

**3. Bituminous Materials:**

Bitumen was used as a bonding and water-proofing agent thousands of years ago. However, the use of bitumen for road-making picked up only in the nineteenth century. As the quest for fuels like petroleum to run automobiles grew and the distillation of crude oil emerged as a major refining industry, the residues known as bitumen and tar found increasing use in constructing bituminous surfaces, which provided superior riding surface.

**The definition for the term, bitumen, given by the American Society for Testing Materials (ASTM) runs thus:**

“Bitumen is a hydrocarbon material of natural or pyrogenous origin, which is in a gaseous, liquid, semi-solid, or solid state, and which is completely soluble in carbon disulphide (CS<sub>2</sub>).”

Of course, bitumen is found to be soluble to a large extent in carbon tetrachloride (CCl<sub>4</sub>) also. Bitumen is a complex organic compound and occurs either as such in nature or can be obtained during the distillation of petroleum; it is generally non-volatile and resistant to most acids, alkalis and salts.

Bitumen occurring in nature as rock intrusions invariably contains inert inorganic materials or minerals; in such a case it is called asphalt. It is also found in lakes (as in Trinidad), in which case it is called lake asphalt. However, in American terminology, bitumen itself is termed asphalt, irrespective of whether it contains inorganic/mineral matter or not. In India, the British terminology is used for the terms bitumen and asphalt.

**Important Properties of Bitumen:**

1. Predominantly hydrocarbons, with small quantities of sulphur, nitrogen and metals.
2. Mostly (up to 99.9%) soluble in carbon disulphide (CS<sub>2</sub>), and insoluble in water.
3. Softens on heating and gets hardened on cooling.
4. Highly impermeable to water.
5. Chemically inert and unaffected by most acids, alkalis and salts.
6. No specific boiling point, melting point or freezing point; a form of ‘softening point’ is used in their characterisation.
7. Although generally hydrophobic (water repellent), they may be made hydrophilic (water liking) by the addition of a small quantity of surface-active agent.
8. Most bitumens are colloidal in nature.

**Desirable Properties of Bitumen as a Road Material:**

1. Workability – Bitumen should be fluid enough at the time of mixing so that the aggregates are fully coated by the binder. Fluidity is achieved either by heating or by cutting back with a thin flux or by emulsifying the bitumen.
2. Durability – There should be little change in viscosity within the usual range of temperatures in the locality.
3. Volatile constituents in bitumen should not be lost excessively at higher temperatures to ensure durability.
4. It should have enough ductility to avoid brittleness and cracking.
5. Strength and adhesion – The bitumen should have good affinity to the aggregates and should not be stripped off in the continued presence of water.
6. Cost-effectiveness.

**A few more terms relating to bitumen/asphalt are:**

**Straight-Run Bitumen:** Bitumen derived from the refining of petroleum for which the viscosity has not been adjusted by blending with flux oil or by softening with any cut-back oil or by any other treatment. It generally has high viscosity.

**Asphalt Cement:**

A binder consisting of bitumen, or a mixture of lake asphalt and bitumen or fluxoils, specially prepared as per prescribed quality and consistency for direct use in paving, usually in the hot condition.

**Oxidised or Blown Bitumen:**

Bitumen obtained by further treatment of straight-run bitumen by running it, while hot, into a vertical column and blowing air through it. In this process, it attains a rubbery consistency with a higher softening point than before.

**Cut-Back Bitumen:**

Asphalt/bitumen dissolved in naphtha or kerosene to lower the viscosity and increase the workability.

**Emulsified Bitumen:**

A mixture in which asphalt cement, in a finely dispersed state, is suspended in chemically treated water.

**Liquid Bitumen:**

Include cut-backs in naphtha and kerosene, as also emulsified asphalts.

**Flux-Oil:**

A bituminous material, generally liquid, used for softening other bituminous materials.

**Bitumen from Petroleum Refining:**

The main source of bitumen is petroleum crude. Refining of petroleum crude involves fractional distillation. The crude oil is heated in a tube-still to about 200°C to 400°C and injected into a fractionating column. As the pressure is suddenly reduced, the volatile fractions with low boiling points get vaporised and go up the column, from where they are carried through condensers.

Gasoline, kerosene, diesel oil, and lubricating oils, constituting the light, medium and heavy distillates with gradually increasing boiling points, thus get collected. The heavy residue left at the bottom is collected as bitumen. Steam is injected into the fractionating column to help in the separation process of the fractions. The steam and vacuum distillation process is only a physical process and does not involve any chemical changes.

In modern refining processes, the distillation is carried out in stages. In the first stage, the temperature in the tube-still is kept relatively low (say 300°C to 350°C) and the light and medium fractions are separated in the fractionating column operating at atmospheric pressure.

The crude left is then passed through another still for subsequent transfer to another column operating under vacuum and injected with steam. The latest process dispenses with steam and relies on dry vacuum only, thus enabling a wide range of bitumen to be produced.

Paraffinic crudes yield, on distillation, an undesirable wax-like residue. Naphthenic crudes yield practically wax-free bitumen; crude from middle-east yields good bitumen. The heavy residue may be blown with air at high temperature in a converter to produce air-blown or oxidised bitumen.

They are stiff even at high atmospheric temperatures. Such bitumen are not used for pavements, but are good as roofing materials and water-proof paints. It is also used as filler material for cracks and joints in concrete pavements.

**There are three types of cut-backs based on the diluent (dilutant or solvent) used:**

1. Rapid-curing (RC) cutback – Bitumen blended with gasoline or naphtha, (highly

volatile, low viscosity)

2. Medium-curing (MC) cutback – Bitumen blended with kerosene or coal tar creosote oil (medium viscosity)

3. Slow-curing (SC) cutback – Bitumen blended with gas oil (low viscosity, highly viscous)

**Each of these has been categorized based on their initial kinematic viscosity values as follows:**

1. RC 70, RC 250, RC 800, RC 3000

2. MC 30, MC 70, MC 250, MC 800, MC 3000

3. SC 70, SC 250, SC 800, SC 3000

Further details and specifications for these cutbacks are given in “IS: 217- 1988: Specification for cutback bitumen, Bureau of Indian Standards, New Delhi, 1993”.

Since cutbacks contain volatile solvent, some of which may enter water bodies and air, they may cause environmental pollution. Also, since the solvent is inflammable, it may increase the possibility of fire hazard and cause concerns related to safety during handling and application. Therefore, cutbacks are being gradually replaced by emulsions.

#### **Bitumen Emulsions:**

A bitumen emulsion is obtained by blending bitumen with water and an additive called an emulsifier. The emulsified suspension contains dispersed minute particles of bitumen (that is, oil in water). In a bituminous emulsion, bitumen is the ‘dispersed’ phase (minutely subdivided particles), while water is the ‘continuous’ phase in which it is not soluble. The amount of bitumen to be mixed with water may range from 40 to 70% depending upon the intended use of the suspension.

Based on the type of emulsifier used, the bitumen particles can be negatively charged or positively charged. If they are negatively charged, ‘anionic bitumen emulsions’ are obtained, and if they are positively charged, ‘cationic emulsions’ are got.

Fatty acids derived from mineral, vegetable or wood sources saponified with sodium or potassium hydroxide are used as emulsifiers for producing anionic emulsion. For cationic emulsions, the emulsifiers are generally amine salts produced by the reaction of organic amine or diamine with acetic acid or hydrochloric acid.

The type of emulsion should be selected based on the mineral composition of the aggregate used for the bituminous mix. For example, for an aggregate rich in silica ( $\text{SiO}_2$ ) which has a strong electronegative charge on the surface, cationic emulsions are suitable with electropositive charge on the suspended bitumen particles. The mix then becomes electrostatically stable and produces a strong layer when compacted.

**Bitumen emulsions, like cutback bitumens, are also classified into three types based on their setting times:**

1. Rapid-setting emulsions (RS)

2. Medium-setting emulsions (MS)

3. Slow-setting emulsions (SS)

Setting, in this context, means separation of the emulsion. When the water in the emulsion evaporates, the minute bitumen particles in the emulsion coat the

surface of the aggregates; curing takes place, by which the compacted layer of the emulsion-aggregate mix hardens and attains strength. Therefore, rapid-setting emulsion sets and cures in a relatively quick manner.

“IS: 3117-2004: Anionic bitumen emulsions” covers anionic emulsions, while “IS: 8887- 2004: Cationic bitumen emulsions” covers cationic emulsions.

**Setting and curing of emulsion mixes are affected by the following factors:**

- I. Gradation, dust, dampness, water absorption and mineral composition and surface charge of/on the aggregates.
- II. Ingredients and quantity of the emulsion used.
- III. Meteorological conditions like climate, weather, temperature, humidity, wind velocity, etc.
- IV. Drainage conditions of the construction site.

**Advantages of Emulsions:**

1. Emulsions can be used under cold and damp weather conditions.
2. Strength properties of bitumen are preserved as they do not need hotmixing.
3. Better coating of aggregates due to low viscosity of the emulsion.
4. Ideal for patch repair work and sealing of cracks as no heating is required and better penetration into even minute cracks is possible.
5. Water-based nature of the emulsions makes them environment-friendly.
6. A lot of energy is conserved as there is no need for intensive heating (only warming is needed, if at all.)

**7. Limitations of Emulsions:**

1. The nature of the aggregate has to be verified before choosing an appropriate emulsion.
2. Setting time varies not only with the type of emulsion, but also with atmospheric conditions at the time of application.
3. Based on the particular need, care should be exercised in choosing the type of emulsion and the quantity needed for the desired grade of bituminous mix.
4. Storage time is relatively restricted.
5. Bitumen emulsions are more expensive than hot-mix bitumen.
6. In general, emulsion-based bituminous pavements using emulsions are not as good as hot- mix constructions for heavy traffic loads.

**Tar:**

Tar is a black or brown to black, viscous, non-crystalline material having binding property. This is, therefore, the other category of bituminous materials.

Tar is obtained from the destructive distillation of organic materials such as coal, petroleum, oil, wood and peat, in the absence of air at about 1000°C. It is completely soluble in carbon tetrachloride (CCl<sub>4</sub>). It contains more volatile

constituents than bitumen and is therefore more susceptible to change in temperature. Generally, tar is used for surface dressing on the wearing course since it has good adhesion in damp conditions.

**Some more terms relating to tar are:**

- a. Coal tar – Tar produced by the destructive distillation of bituminous coal.
- b. Coke-oven tar – A variety of coal tar obtained as a by-product from the destructive distillation of coal in the production of coke.
- c. Oil-gas tar – A petroleum tar produced by cracking oils at high temperature in the production of oil-gas.
- d. Water-gas tar – A petroleum tar produced by cracking oils at high temperature in the production of carburetted water-gas.
- e. Refined tar – Produced from crude tar by distillation to remove water and to produce a residue of desired consistency.
- f. Road tar – A tar refined in quality and consistency for use in paving of roads.
- g. Pitch – Black or dark brown solid cementitious residue which gradually liquefies when heated and which is produced by distilling off the volatile constituents from tar.

**Specifications for Road Tars:**

Indian Standards classify road tars for paving purposes into five grades — RT1, RT2, RT3, RT4, and RT5, meant for specific purposes.

These are covered by “IS: 215-1995: Road tar: Specifications, Bureau of Indian Standards, New Delhi, 2000”.

**The grades and specific uses are given below in Table 6.12:**

**Table 6.12 (IS: 215-1995, 2000)**

Grade	Specific uses
RT-1	Surface dressing for very cold weather conditions and at very high elevation on hill roads.
RT-2	Surface dressing under normal climatic conditions.
RT-3	(a) Surface dressing and renewal coats. (b) Pre-coating chippings; light chipping carpet.
RT-4	Premix tar macadam
RT-5	Grouting

**Low Temperature Tar:**

The coal-tar produced in the manufacture of coking coal requires carbonation at high temperatures above 1000°C. In view of the increasing demand for road tars in recent years, a new technology known as low temperature carbonisation has come into vogue.

In this, the carbonisation of coal is carried out in the temperature range of 600°-750°C in a smokeless fuel process. The crude tar thus produced is successfully used for making road tars; these are known as low temperature tars.

**Bitumen versus Tar:****A comparison of bitumen and tar is given below:**

- i. Aggregates coated with tar exhibit lower stripping action than those coated with bitumen.
- ii. Tar is more susceptible to temperature than bitumen. It becomes liquid at relatively lower temperature.
- iii. Tar is not easily dissolved in petroleum solvents; so it can be preferred for paving parking areas, where oils might drip from vehicles.
- iv. Since more setting time is required for tar, it may be processed at a mixing plant and carried to the construction site.
- v. In view of the higher free carbon content, tar is more brittle than bitumen.
- vi. As tars have more phenol content, they can get more easily oxidised than bitumen.
- vii. At higher temperatures, tar may be more easily affected than bitumen.
- viii. As more time is required for tar to set, tar-paved roads need to be closed to traffic for a longer time. Both bitumen and tar appear black in colour in a large mass, but appear brown in thin films.

**Tar-Bitumen Mixtures:**

A mixture of tar and bitumen provides a binder of excellent quality as it has a decreased volume of insoluble benzene is decreased. Such mixtures have lower temperature susceptibility and reduced penetration value. Rheological properties of the binder also get altered. Generally, a mixture of tar and bitumen in equal proportions is considered to be an ideal binder.

**Bituminous Mixes:**

Bituminous mixes for paving purposes consist of coarse aggregate, fine aggregate, filler material, bitumen, and air voids, suitably proportional and blended to provide a strong, stable and durable pavement.

The main aim of mix design is to determine the optimum bitumen content that will hold the mineral aggregates of suitable gradation together as a compact layer that resists the traffic loads. The mix should have a certain minimum air voids to allow volume changes during service either because of temperature changes or repeated loading from the traffic.

**Requirements of Bituminous Mixes:**

**The following are the important requirements of bituminous mixes for pavements:**

**(i) Stability:**

This is the resistance to deformation under traffic loads; it is a function of inter-particle friction and cohesion offered by the bitumen binder. It is related to the density of the mix which is dependent on the voids content. The more the density, the more stable the mix; however, a minimum voids content is necessary to allow for volume changes which cannot be fully prevented.

**(ii) Durability:**

This is the resistance to weathering action and abrasion from traffic. Spalling, stripping and formation of pits, corrugations and potholes can result from weathering and traffic. Excessive strain may cause cracking or plastic failure.

**(iii) Flexibility:**

This is a measure of the resistance to long-term deformations and shapes of the road base, sub-base and subgrade; this depends on the flexural or bending strength of the pavement.

**(iv) Skid Resistance:**

The resistance of the surface of the pavement laid with the bituminous mix to skidding of the tyres of vehicles is called skid resistance. The surface texture should be such as to provide grip or friction even under wet conditions. This is important in the prevention of accidents.

**(v) Workability:**

This is the ease with which the mix can be placed in position and compacted. It depends on the aggregate characteristics like the size, shape texture and gradation, bitumen content and nature of the bituminous material.

**(vi) Economy:**



The overall cost in achieving the desired qualities of the mix and the pavement should be a minimum, consistent with quality

**The desired qualities of the bituminous mixes, therefore, have to be achieved by:**

1. Using good quality aggregate, which is hydrophobic and has rough surface texture, with appropriate grading and voids content.
2. Using bituminous binder of the correct quality and consistency based on the specific purpose for which the pairing mix is intended.
3. Controlling the voids content and the bitumen content to achieve the desirable qualities listed above.

#### **4. Cement, Cement Mortar and Cement Concrete:**

Cement concrete is a versatile material which has revolutionised civil engineering construction during the twentieth century. A fresh cement concrete mix consists of cement, mineral aggregates (coarse aggregate and fine aggregate), and water.

A well-designed cement concrete mix sets and hardens due to the binding property of the cements, forms a mix with minimum void space and on curing with water, provides a strong, stable and durable pavement for a highway, resisting repetitive impact from wheel loads and also withstanding adverse environmental conditions.

Thus, a cement concrete pavement is the most superior highway construction primarily from the point of view of strength and durability. The ingredients of the concrete mix, viz., the coarse aggregate (broken stone) and fine aggregate (sand) have to be selected carefully to satisfy the desirable properties for concrete-making. Potable water is generally considered satisfactory making cement concrete. Cement is used also as an additive to soil to produce soil-cement used as the primarily material in the construction of low-cost roads.

#### **Cement:**

Cement is the most important ingredient of cement concrete or cement mortar (cement mortar is a suitable mixture of cement and fine aggregate or sand in appropriate proportions).

Cement mixed with water becomes a paste and spreads over the aggregates forming a thin film; chemical reactions take place leading to the formation of silicates and aluminates. Subsequently, setting takes place and in the presence of water, hydration takes place leading to hardening of the concrete.

The most common cement is what is now known as the Ordinary Portland Cement (OPC). Calcareous and silicate compounds are blended and heated to high temperatures (1500°C) to form clinkers of new chemical compounds, which when ground to fine particles result in 'cement'.

The primary ingredients of cement are:

- (i) Tricalcium silicate ( $3\text{CaO} \cdot \text{SiO}_2$ )  $\approx$  50%
- (ii) Dicalcium silicate ( $2\text{CaO} \cdot \text{SiO}_2$ )  $\approx$  22%

- (iii) Tricalcium aluminate ( $3\text{CaO}\cdot\text{Al}_2\text{O}_3$ )  $\approx 9\%$
- (iv) Tetracalcium aluminoferrite ( $4\text{CaO}\cdot\text{Al}_2\text{O}_3\cdot\text{Fe}_2\text{O}_3$ )  $\approx 9\%$
- (v) Miscellaneous compounds  $\approx 10\%$

The silicates contribute to the immediate strength gain while the other ingredients are responsible for the long-term strength gain. The properties of cement can be modified by blending it in different admixtures in the manufacturing process.

The following are the different types cements widely used for specific purposes in India:

- i. Ordinary Portland cement (OPC)
- ii. Rapid hardening cement
- iii. High alumina cement
- iv. Low heat cement
- v. Portland blast furnace slag cement
- vi. White cement

### **Function of soil as highway Subgrade**

Soil is used for the construction of the bottom most layer of the pavement, i.e. sub-grade. Here is a short details of the sub-grade and its function.:

Sub-grade is the layer of the pavement whose main function is to support the upper layers of the pavement and to provide the good drainage facility to the infiltrating rain water. It has to act as a single structure along with other layers of the pavement.

- Soil is compacted to its maximum dry density which can be achieved by using the optimum moisture content and the methods of compaction control. Strength has to be ensured which is required for the given design thickness of the pavement.
- Strength analysis and the thickness of pavement are inter linked because more thickness of the pavement is needed if the soil is weak but if the soil possess a good strength then less thickness is needed.

This is ensured by using the CBR (California Bearing Ratio) Test which is produced or was first used by the California State Highway Department. Using the CBR test and the empirical charts you can find out the thickness of the flexible pavement required above the sub-grade.

### **Tests On Soil:**

Sub grade soil is an integral part of the road pavement structure as it provides the support to the pavement from beneath. The sub grade soil and its properties are important in the design of pavement structure. The main function of the sub grade is to give adequate support to the pavement and for this the sub grade should possess sufficient stability under adverse climatic and loading conditions. Therefore, it is very essential to evaluate the sub grade by conducting tests.

The tests used to evaluate the strength properties of soils may be broadly divided into three groups:

- Shear tests
- Bearing tests
- Penetration tests

Shear tests are usually carried out on relatively small soil samples in the laboratory. In order to find out the strength properties of soil, a number of representative samples from different locations are tested. Some of the commonly known shear tests are direct shear test, triaxial compression test, and unconfined compression test.

Bearing tests are loading tests carried out on sub grade soils in-situ with a load bearing area. The results of the bearing tests are influenced by variations in the soil properties within the stressed soil mass underneath and hence the overall stability of the part of the soil mass stressed could be studied.

Penetration tests may be considered as small scale bearing tests in which the size of the loaded area is relatively much smaller and ratio of the penetration to the size of the loaded area is much greater than the ratios in bearing tests. The penetration tests are carried out in the field or in the laboratory.

### **California Bearing Ratio: methods of finding CBR valued in the laboratory and at site and their significance**

#### **California Bearing Ratio Test**

In most cases, CBR decreases as the penetration increases. The ratio at 2.5 mm penetration is used as the CBR. In some case, the ratio at 5 mm may be greater than that at 2.5 mm. If this occurs, the ratio at 5 mm should be used. The CBR is a measure of resistance of a material to penetration of standard plunger under controlled density and moisture conditions. The test procedure should be strictly adhered if high degree of reproducibility is desired. The CBR test may be conducted in re-moulded or undisturbed specimen in the laboratory. The test is simple and has been extensively investigated for field correlations of flexible pavement thickness requirement.

#### **Test Procedure**

- The laboratory CBR apparatus consists of a mould 150 mm diameter with a base plate and a collar, a loading frame and dial gauges for measuring the penetration values and the expansion on soaking.
- The specimen in the mould is soaked in water for four days and the swelling and water absorption values are noted. The surcharge weight is placed on the top of the specimen

in the mould and the assembly is placed under the plunger of the loading frame.

- Load is applied on the sample by a standard plunger with dia of 50 mm at the rate of 1.25 mm/min. A load penetration curve is drawn. The load values on standard crushed stones are 1370 kg and 2055 kg at 2.5 mm and 5.0 mm penetrations respectively.

CBR value is expressed as a percentage of the actual load causing the penetrations of 2.5 mm or 5.0 mm to the standard loads mentioned above. Therefore,

$$CBR = \frac{\text{load carries by specimen}}{\text{load carries by standard specimen}} \times 100$$

Two values of CBR will be obtained. If the value of 2.5 mm is greater than that of 5.0 mm penetration, the former is adopted. If the CBR value obtained from test at 5.0 mm penetration is higher than that at 2.5 mm, then the test is to be repeated for checking. If the check test again gives similar results, then higher value obtained at 5.0 mm penetration is reported as the CBR value. The average CBR value of three test specimens is reported as the CBR value of the sample.

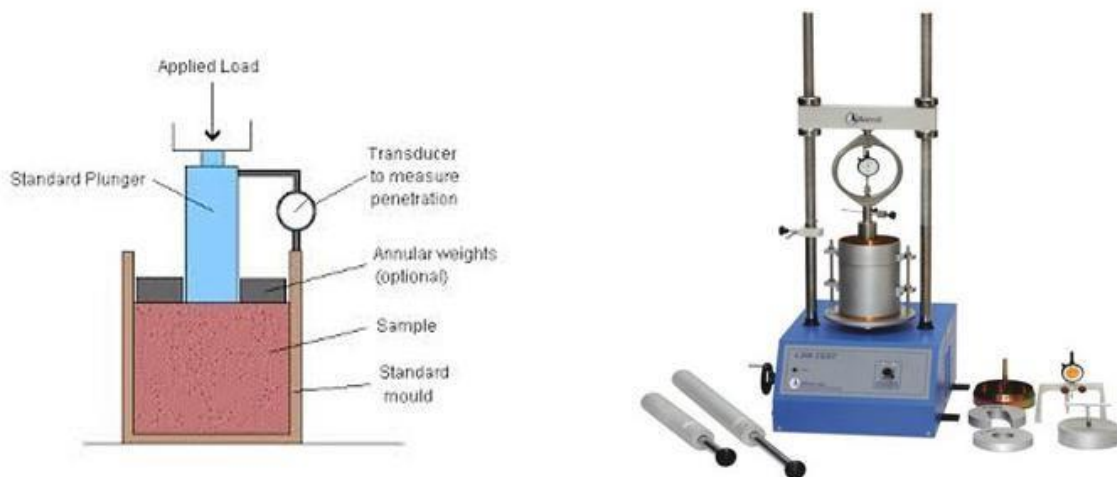

Fig.CBR Testing machine

## Tests on aggregates:

### Abrasion test:

Due to the movement of traffic, the road stones used in the surfacing course are subjected to wearing action at the top. Resistance to wear or hardness is hence an essential property for road aggregates especially when used in wearing course. Thus road stones should be hard enough to resist the abrasion due to the traffic.

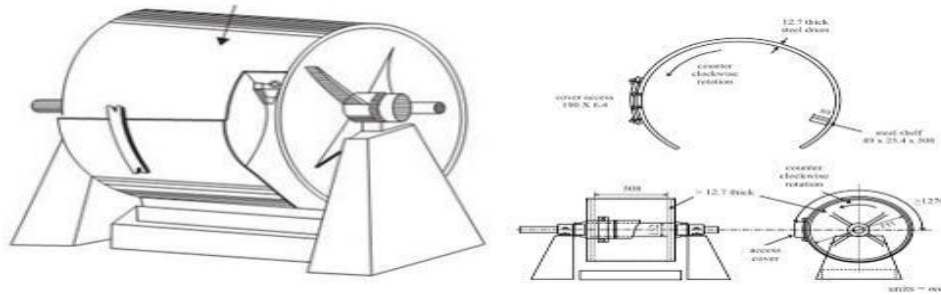

Fig. Los Angles Abrasion Machine

### Procedure:

- 1) Take the clean and dried aggregates in an oven at 105-110° C.
- 2) Sieve the given aggregates in sieve size 20-12.5mm and weigh that aggregate in 2.5kg.
- 3) Again sieve the aggregate in sieve size is 12.5-10mm and take that aggregates in 2.5 k. i.e., W1 gm (2.5+2.5=5kg)
- 4) Pour the given taking aggregates into the los angles abrasion machine.
- 5) Put the steel balls into the abrasion machine after pouring the aggregates.
- 6) Start the machine and rotating the drum for 100 revolutions and stop the machine.
- 7) After stopping the machine, take out the aggregates and sieve the aggregates in 1.7mm sieve size and take the retained aggregates and note down its weight i.e, W2 gm.
- 8) Then, Los Angles Abrasion value=  $(W1-W2/W1) \times 100 \%$

### Impact test:

Toughness is the property of a material to resist impact. Due to traffic loads the road stones are subjected to the pounding action or impact and there is possibility of stones breaking into smaller pieces. The road stones should therefore be tough enough to resist fracture under impact. A test designed to evaluate the toughness of stones i.e. the resistance of the stones to fracture under repeated impacts may be an impact test for road aggregate.

The aggregate impact value indicates a relative measure of the resistance of an aggregate to a sudden shock or an impact, which in some aggregate differs from its resistance to a slow compressive load. The method of tests specifies the procedure for determining the aggregate impact value of coarse aggregate.

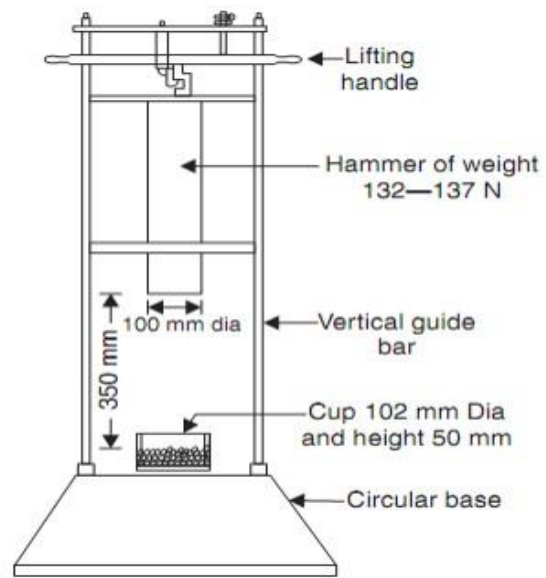

Fig. Impact test Machine

## Procedure:

- i. Take clean and dry aggregate and sieve on IS 12.5 mm and 10.00 mm sieve.
- ii. Collect the aggregate passing IS 12.5mm sieve and retained on IS 10.0mm Sieve.
- iii. Find the weight of empty cylindrical measure. Let the weight be 'a' g.
- iv. Fill the aggregate in the cylindrical measure in three layers, tamping each layer 25 times with the rounded end of the tamping rod.
- v. Roll the tamping rod over aggregate surface and remove excess aggregate, if any.
- vi. Find the weight of the cylindrical measure with aggregate. Let the weight be 'b' g. Thus the weight of aggregate =  $W1 = (b - a)$
- vii. Transfer all the aggregate from the cylindrical measure to the test cylinder in one layer and tamp the layer 25 times with the rounded end of the tamping rod.
- viii. Fix the test cylinder firmly to the base of the impact tester.
- ix. Adjust the height of fall of the plunger to  $380 \pm 5$  mm and set the blow counter to zero.
- x. Lift the plunger gently and allow it to drop. This is one blow. Give 15 such blows.
- xi. Take out the test cylinder and sieve the crushed material on IS 2.36 mm sieve. Find the weight of material passing the sieve. Let weight be  $W2$  g.
- xii. Find the weight of aggregate retained on this sieve. Let the weight be  $W3$  g.

g. Then,

$$\text{Aggregate impact value} = W2 / W1 * 100 \% \text{ And}$$

$$\text{percentage of dust} = W3 / W1 * 100 \%$$

## Crushing strength test

The Principal mechanical properties required in road stones are (i) Satisfactory resistance to crushing under the roller during construction and (ii) adequate resistance to surface abrasion under traffic. Also stresses under rigid tyre rims of heavily loaded animal drawn vehicles are high enough to consider the crushing strength of road aggregate as an essential requirement in India. Crushing strength of road aggregate may be determined either on aggregate or on cylindrical specimens cut out of rocks. These two tests are quite different is not only the approach but also is the expression of the results.

Aggregate used in road construction, should be strong enough to resist crushing under traffic wheel loads. If the aggregate are weak, the stability of the pavement stretches is likely to be adversely affected, the strength of coarse



aggregate is assessed by aggregate crushing test. The aggregate crushing value provides a relative measure of resistance to crushing under gradually applied compressive load. To achieve a high quality of pavement, aggregate possessing low aggregate value should be preferred.

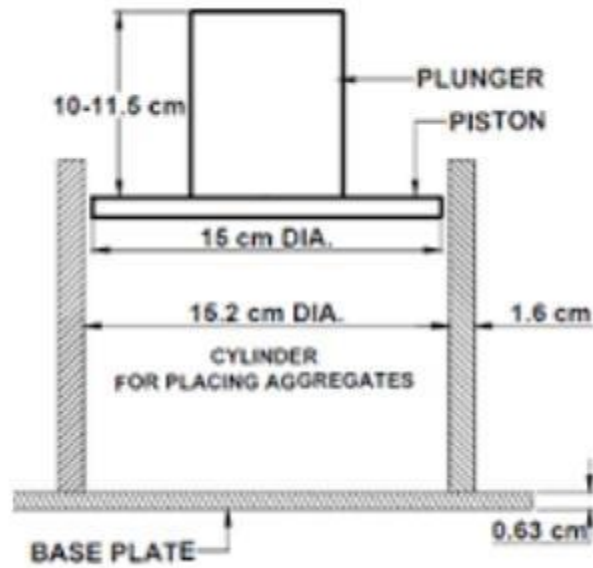

Fig. Arrangement of Crushing strength test

## Testing

### Procedure:

- i. Select clean and dry aggregate passing through IS 12.5 mm and retained on IS 10.0 mm sieve.
- ii. Weight the empty cylindrical measure. Let the weight be 'a' g
- iii. Fill the aggregate in the cylindrical measure in three layers, tamping each layer 25 times with the rounded end of the tamping rod. Weigh the cylindrical measure with aggregate. Let the weight be 'b' grams. Thus the weight of aggregate =  $W_1$  g
- iv. Transfer the aggregate into the steel cylinder again in three layers tamping each layer 25 times
- v. Place the plunger in the steel cylinder such that the piston rests horizontally over the aggregate surface.
- vi. Keep the assembly of steel cylinder with plunger in the compression testing machine.
- vii. Set the pointer to read zero and apply the compressive load of 40 tonnes.
- viii. Stop the machine. Take out the assembly.
- ix. Sieve the crushed material on IS 2.36 mm sieve and find the weight of material passing this sieve. Let the weight be  $W_2$  g.
- x. Then Aggregate crushing value =  $W_2 / W_1 \times 100 \%$

## Specific Gravity and Water Absorption Test on Aggregates

The specific gravity of an aggregate is considered to be a measure of strength or quality of the material. Stones having low specific gravity are generally weaker than those with higher specific gravity values. The specific gravity test helps in the identification of stone.

Water absorption gives an idea of strength of rock stones having more water absorption are more porous in nature and are generally considered unsuitable unless they are found to be acceptable based on strength, impact and hardness.

### Testing Procedure :

1. Take about 2kg of given aggregates passing IS 20mm sieve and retained on 10mm sieve.
2. Keep the aggregate in density basket and then keep the basket in water.
3. Allow the aggregate and basket to be in water for 24 hours.
4. After 24 hours find the suspended weight of basket with aggregate.
5. Remove the basket out of water and remove the aggregate.
6. Keep the empty basket back in water and find the suspended weight.
7. Wipe the surface of aggregate using a cotton cloth to make them surface dry.
8. Find the weight of surface dry aggregate in air.
9. Keep the aggregate in oven at 110° C for 24 hours.
10. Now find the weight of dried aggregate in air.
11. Then specific gravity and Water absorption is calculated from the relation:

$$\text{Specific gravity} = \frac{W_4}{W_3 - (W_1 - W_2)}$$

$$\text{Water absorption} = \frac{W_3 - W_4}{W_4} * 100 \%$$

### Soundness test

To study the resistance of aggregates to weathering action, by conducting accelerated weathering test cycle.

### Testing Procedure

1. In order, to quicken the effects of weathering due to alternate wet-dry or freeze-thaw cycles in the laboratory, the resistance to disintegration of aggregate is determined by using saturated solution of sodium sulphate or magnesium sulphate.

2. Clean, dry aggregates of specified size is weighed and counted. Then immersed in the saturated solution of sodium sulphate or magnesium sulphate for 16 to 18 hours.
3. Then the aggregates are dried in an oven at 105-110°C to a constant weight, thus making one cycle of immersion and drying.
4. The number of such cycles is decided by prior agreement and then the specimens are tested. After completing the final cycle, the sample is dried and each fraction of aggregate is examined visually to see if there is any evidence of excessive splitting, crumbling or disintegration of the grains.
5. Sieve analysis is carried out to note the variation in gradation from original. The coarse aggregate fraction of each size range is sieved on specified sieve sizes.

**Desirable value**

IRC has specified 12 percent as the maximum permissible loss in soundness test after 5 cycles with sodium sulphate, for the aggregate to be used in bituminous surface dressing, penetration macadam and bituminous macadam constructions.

## **UNIT 4-ROAD PAVEMENTS**

### **Introduction:**

A highway pavement is a structure consisting of superimposed layers of processed materials above the natural soil sub-grade, whose primary function is to distribute the applied vehicle loads to the sub-grade. The pavement structure should be able to provide a surface of acceptable riding quality, adequate skid resistance, favorable light reflecting characteristics, and low noise pollution. The ultimate aim is to ensure that the transmitted stresses due to wheel load are sufficiently reduced, so that they will not exceed bearing capacity of the sub-grade. Two types of pavements are generally recognized as serving this purpose, namely flexible pavements and rigid pavements. This chapter gives an overview of pavement types, layers, and their functions, and pavement failures. Improper design of pavements leads to early failure of pavements affecting the riding quality.

### **Requirements of a pavement**

An ideal pavement should meet the following requirements:

- Sufficient thickness to distribute the wheel load stresses to a safe value on the sub-grade soil,
- Structurally strong to withstand all types of stresses imposed upon it,
- Adequate coefficient of friction to prevent skidding of vehicles,
- Smooth surface to provide comfort to road users even at high speed,
- Produce least noise from moving vehicles,
- Dust proof surface so that traffic safety is not impaired by reducing visibility,
- Impervious surface, so that sub-grade soil is well protected, and Long design life with low maintenance cost.

### **Types of pavements**

The pavements can be classified based on the structural performance into two, flexible pavements and rigid pavements. In flexible pavements, wheel loads are transferred by grain-to-grain contact of the aggregate through the granular structure. The flexible pavement, having less flexural strength, acts like a flexible sheet (e.g. bituminous road). On the contrary, in rigid pavements, wheel loads are transferred to sub-grade soil by flexural strength of the pavement and the pavement acts like a rigid plate (e.g. cement concrete roads). In addition to these, composite pavements are also available. A thin layer of flexible pavement over rigid pavement is an ideal pavement with most desirable characteristics. However, such pavements are rarely used in new construction because of high cost and complex analysis required.

### **Flexible pavements**

Flexible pavements will transmit wheel load stresses to the lower layers by grain-to-grain transfer through the points of contact in the granular structure (see Figure ).

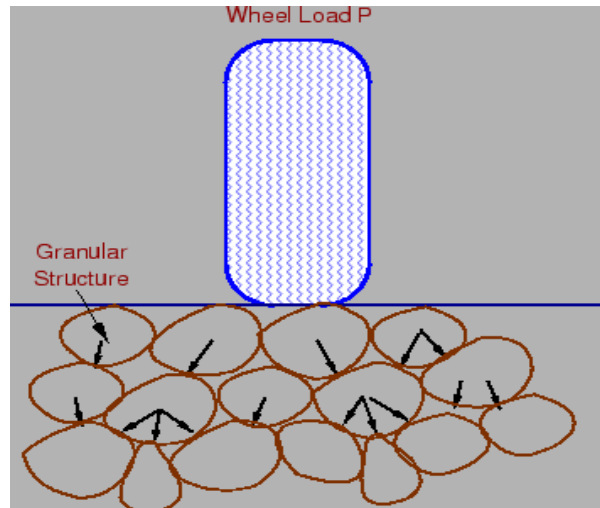

**Figure :** Load transfer in granular structure

The wheel load acting on the pavement will be distributed to a wider area, and the stress decreases with the depth. Taking advantage of this stress distribution characteristic, flexible pavements normally have many layers. Hence, the design of flexible pavement uses the concept of layered system. Based on this, flexible pavement may be constructed in a number of layers and the top layer has to be of best quality to sustain maximum compressive stress, in addition to wear and tear. The lower layers will experience lesser magnitude of stress and low quality material can be used. Flexible pavements are constructed using bituminous materials. These can be either in the form of surface treatments (such as bituminous surface treatments generally found on low volume roads) or, asphalt concrete surface courses (generally used on high volume roads such as national highways). Flexible pavement layers reflect the deformation of the lower layers on to the surface layer (e.g., if there is any undulation in sub-grade then it will be transferred to the surface layer). In the case of flexible pavement, the design is based on overall performance of flexible pavement, and the stresses produced should be kept well below the allowable stresses of each pavement layer.

## Types of Flexible Pavements

The following types of construction have been used in flexible pavement:

- Conventional layered flexible pavement,
- Full - depth asphalt pavement, and
- Contained rock asphalt mat (CRAM).

**Conventional flexible pavements** are layered systems with high quality expensive materials are placed in the top where stresses are high, and low quality cheap materials are placed in lower layers.

**Full - depth asphalt pavements** are constructed by placing bituminous layers directly on the soil sub-grade. This is more suitable when there is high traffic and local materials are not available.

**Contained rock asphalt mats** are constructed by placing dense/open graded aggregate layers in between two asphalt layers. Modified dense graded asphalt concrete is placed above the sub-grade will significantly reduce the vertical compressive strain on soil sub-grade and protect from surface water.

### Typical layers of a flexible pavement

Typical layers of a conventional flexible pavement includes seal coat, surface course, tack coat, binder course, prime coat, base course, sub-base course, compacted sub-grade, and natural sub-grade (Figure 2).

#### **Seal Coat:**

Seal coat is a thin surface treatment used to water-proof the surface and to provide skid resistance.

#### **Tack Coat:**

Tack coat is a very light application of asphalt, usually asphalt emulsion diluted with water. It provides proper bonding between two layers of binder course and must be thin, uniformly cover the entire surface, and set very fast.

#### **Prime Coat:**

Prime coat is an application of low viscous cutback bitumen to an absorbent surface like granular bases on which binder layer is placed. It provides bonding between two layers. Unlike tack coat, prime coat penetrates into the layer below, plugs the voids, and forms a water tight surface.

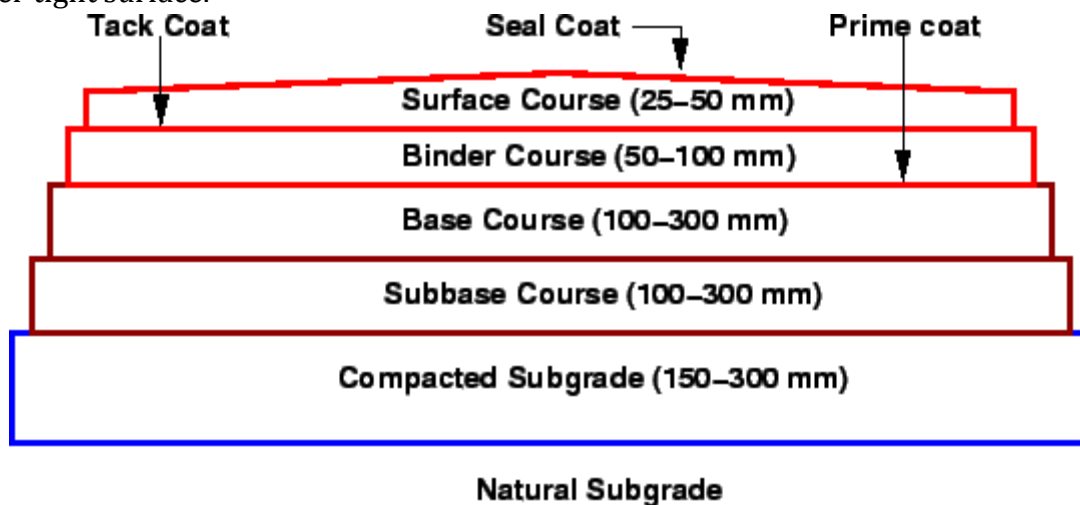

**Figure:** Typical cross section of a flexible pavement

### **Surface course**

Surface course is the layer directly in contact with traffic loads and generally contains superior quality materials. They are usually constructed with dense graded asphalt concrete (AC). The functions and requirements of this layer are:

- It provides characteristics such as friction, smoothness, drainage, etc. Also it will prevent the entrance of excessive quantities of surface water into the underlying base, sub-base and sub-grade,
- It must be tough to resist the distortion under traffic and provide a smooth and skid-resistant riding surface,
- It must be water proof to protect the entire base and sub-grade from the weakening effect of water.

### **Binder course**

This layer provides the bulk of the asphalt concrete structure. Its chief purpose is to distribute load to the base course. The binder course generally consists of aggregates having less asphalt and doesn't require quality as high as the surface course, so replacing a part of the surface course by the binder course results in more economical design.

### **Base course**

The base course is the layer of material immediately beneath the surface of binder course and it provides additional load distribution and contributes to the sub-surface drainage. It may be composed of crushed stone, crushed slag, and other untreated or stabilized materials.

### **Sub-Base course**

The sub-base course is the layer of material beneath the base course and the primary functions are to provide structural support, improve drainage, and reduce the intrusion of fines from the sub-grade in the pavement structure. If the base course is open graded, then the sub-base course with more fines can serve as a filler between sub-grade and the base course. A sub-base course is not always needed or used. For example, a pavement constructed over a high quality, stiff sub-grade may not need the additional features offered by a sub-base course. In such situations, sub-base course may not be provided.

### **Sub-grade**

The top soil or sub-grade is a layer of natural soil prepared to receive the stresses from the layers above. It is essential that at no time soil sub-grade is overstressed. It should be compacted to the desirable density, near the optimum moisture content.



## Failure of flexible pavements

The major flexible pavement failures are fatigue cracking, rutting, and thermal cracking. The fatigue cracking of flexible pavement is due to horizontal tensile strain at the bottom of the asphaltic concrete. The failure criterion relates allowable number of load repetitions to tensile strain and this relation can be determined in the laboratory *fatigue test* on asphaltic concrete specimens. Rutting occurs only on flexible pavements as indicated by permanent deformation or rut depth along wheel load path. Two design methods have been used to control rutting: one to limit the vertical compressive strain on the top of subgrade and other to limit rutting to a tolerable amount (12 mm normally). Thermal cracking includes both low-

## Rigid pavements

Rigid pavements have sufficient flexural strength to transmit the wheel load stresses to a wider area below. A typical cross section of the rigid pavement is shown in Figure 3. Compared to flexible pavement, rigid pavements are placed either directly on the prepared sub-grade or on a single layer of granular or stabilized material. Since there is only one layer of material between the concrete and the sub-grade, this layer can be called as base or sub-base course.

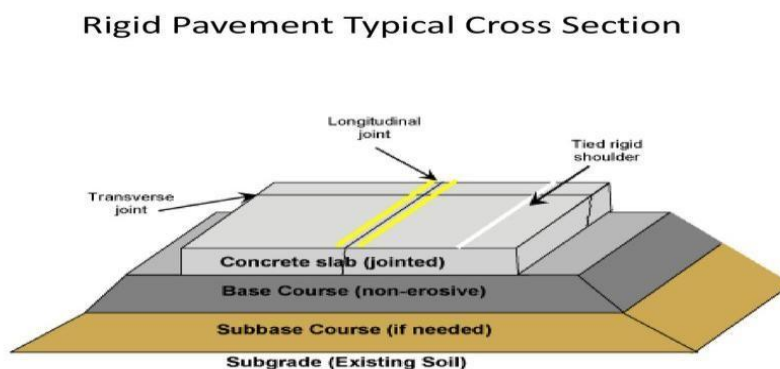

84

temperature cracking and thermal fatigue cracking.

### Figure 3: Typical Cross section of Rigid pavement

In rigid pavement, load is distributed by the slab action, and the pavement behaves like an elastic plate resting on a viscous medium. Rigid pavements are constructed by Portland cement concrete (PCC) and should be analyzed by plate theory instead of layer theory, assuming an elastic plate resting on viscous foundation. Plate theory is a simplified version of layer theory that assumes the concrete slab as a medium thick plate which is plane before loading and to remain plane after loading. Bending of the slab due to wheel load and temperature variation and the resulting tensile

and flexural stress.

## Load Transfer Mechanism

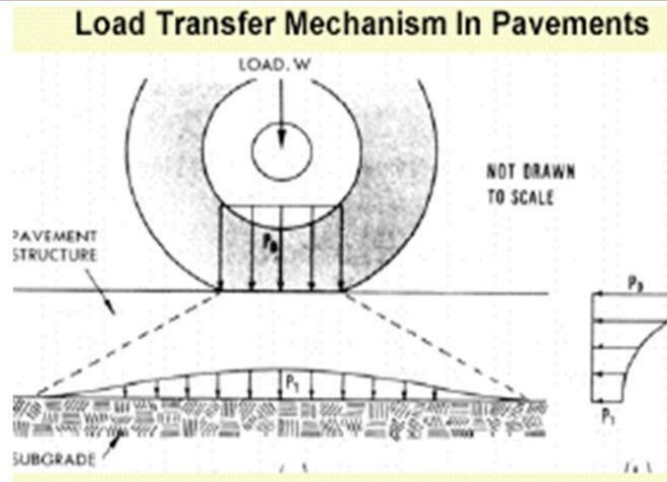

**Figure 4 :** Load transfer in rigid pavement

### Types of Rigid Pavements

Rigid pavements can be classified into four types:

- Jointed plain concrete pavement (JPCP),
- Jointed reinforced concrete pavement (JRCP),
- Continuous reinforced concrete pavement (CRCP), and
- Pre-stressed concrete pavement (PCP).

#### Jointed Plain Concrete Pavement:

are plain cement concrete pavements constructed with closely spaced contraction joints. Dowel bars or aggregate interlocks are normally used for load transfer across joints. They normally have a joint spacing of 5 to 10m.

#### Jointed Reinforced Concrete Pavement:

Although reinforcements do not improve the structural capacity significantly, they can drastically increase the joint spacing to 10 to 30m. Dowel bars are required for load transfer. Reinforcements help to keep the slab together even after cracks.

Continuous Reinforced Concrete Pavement:

Complete elimination of joints are achieved by reinforcement.

#### Failure criteria of rigid pavements:

Traditionally fatigue cracking has been considered as the major, or only criterion for rigid pavement design. The allowable number of load repetitions to cause fatigue cracking depends on the stress ratio between flexural tensile stress and concrete modulus of rupture. Of late, pumping is identified as an important failure criterion. Pumping is the ejection of soil slurry through the joints and cracks of cement concrete pavement, caused during the downward movement of slab under the heavy wheel loads. Other major types of distress in rigid pavements include faulting,

spalling, and deterioration.

## **Components of rigid pavement and there Functions:**

1. Prepared soil subgrade.
2. Granular sub-base (GSB) or drainage layer.
3. Base course/ (DLC-Dry lean concrete).
4. CC pavement slab using PQC (paving quality concrete).

### **1. Prepared soil subgrade:**

- ❖ The soil subgrade of rigid pavement consist of natural or selected soil from identified borrow pits fulfilling the specified requirements.
- ❖ The soil subgrade is well compacted to the desired density and to the required thickness.
- ❖ The soil subgrade is the lower most layer of the pavement structure which ultimately supports all other pavement layer and traffic loads.
- ❖ A good soil subgrade / well compacted and prepared soil subgrade gives long service life to the pavement.

### **2. Granular sub-base (GSB) or drainage layer:**

- ❖ The GSB course has to serve as an effective drainage layer of the rigid pavement to prevent early failures due to excessive moisture content in the subgrade soil.
- ❖ Crushed stone aggregate are preferred In the granular subbase course as this material has high permeability and serves as a effective drainage layer.
- ❖ Coarse graded aggregates with low percent of fines (<5% finer than 75 micron sieve) will serve as good drainage layer.
- ❖ An effective drainage layer under the CC pavements have the following benefits:
  - a. Increases in service life and improved performance of CC pavements.
  - b. Prevention of early failures of the rigid pavements due to pumping and blowing.
  - c. Protection of the subgrade against frost action in the frost suceptible areas.

### **3. Base course: ( Dry lean concrete):**

- ❖ The granular base course is generally provided under the CC pavement slab in low volume roads and also in roads with moderate traffic loads.
- ❖ On roads carrying heavy to very heavy traffic loads high quality base course materials such as dry lean concrete are preferred.
- ❖ In the base course of the CC pavement as they are designed for a life of 30 years or more with good maintenance. The CC pavement are expressed to provide a service life of 40 years or even more.

- ❖ The DLC layer provides a uniform support, high K value and excellent working platform for laying the PQC slab with a sensor paver.
- ❖ The suppression member is spread on the top of the DLC/ base course before laying the CC pavement slab.

#### **4.CC pavement slab: (paving quality concrete (PQC):**

- ❖ M-40 cement concrete mix with a minimum flexural strength of 45 kg/cm<sup>2</sup> is recommended by the IRC for use in the CC-pavements of highways with heavy to very heavy traffic loads.
- ❖ The C pavement slab is extended to withstand the flexural stress caused by the heavy traffic loads and the warping effects in the CC pavements due to the temperature variations.
- ❖ The high quality CC mix with high flexural strength is used for the construction of PQC slab of the CC pavement.
- ❖ The CC pavement slab has considerable flexural strength and spreads the applied load/ wheel loads over a large area by slab action.
- ❖ The slab prevents the infiltration of excess surface water into the sub-base.

#### **Sub-grade preparation:**

This work shall consist of the preparation of subgrade in embankment, or in cut by scarifying, watering, compacting and shaping existing or previously placed material in accordance with these Specifications and to the lines, levels, grades, dimensions and cross sections shown on the Drawings or as required by the Engineer.

All subgrade material shall be from sources, which the contractor shall propose and which shall be approved by the Engineer. The material shall be free from roots, sods or other deleterious material and when compacted to 98% of maximum dry density determined in accordance with STP 4.3 shall have a 4 daysoaked CBR value of not less than 5%. Subgrade material shall satisfy the following criteria: · Liquid limit of soil fraction passing 0.425 mm sieve not to exceed 50% (STP 3.2) · Plasticity index of soil fraction passing 0.425 mm sieve not to exceed 15% (STP 3.2) Any subgrade material in cut or existing old embankment, which is found to be unsuitable, shall be removed and replaced as directed by the Engineer.

#### **Construction Methods**

The subgrade shall be prepared over the full width of the embankment including shoulders. Part width working may be allowed with the prior written approval of the Engineer. The subgrade shall be prepared in lengths of not less than 100 metres at any one time, unless otherwise approved by the Engineer. Subgrade material shall be scarified to a depth of 150 mm until the soil is fully loosened. Any lumps or clods shall be removed or broken to pass a 50 mm sieve. If the Drawings require the subgrade to be compacted for a depth greater than 150 mm, the work shall be carried out in more than one layer, the material in the upper layer being first removed in the case of road sections in cut. The moisture content of the sub-

grade material before compaction shall be within  $\pm 2\%$  of the predetermined optimum moisture content established in accordance with STP 4.3 (Standard Compaction). The achieved dry density after compaction of the subgrade layer shall not be less than 98% of maximum dry density as determined in accordance with STP 4.3. When necessary, each layer, before being compacted, shall be allowed to dry or be watered to bring the moisture content to within  $\pm 2\%$  of optimum to make possible its compaction to the required dry density. The material shall be so worked as to have a uniform moisture content through the entire layer. The subgrade material shall be compacted uniformly by use of adequate and appropriate compaction equipment. The compaction shall be done in a longitudinal direction along the embankment and shall generally begin at the outer edges and progress toward the centre in such a manner that each section receives equal compactive effort.

Samples to determine the compaction shall be taken regularly with a set of three samples for each 1,000 square metres of finished layer or as decided by the Engineer will be carried out according to STP 6.2. If the test results show that the density is less than the required dry density, the Contractor shall carry out further compaction to obtain at least the required dry density. The compacted subgrade layer shall be approved by the Engineer before the Contractor can commence a new layer.

The surface of the finished subgrade shall be neat and workmanlike and have the required form, super elevation, levels, grades and cross section. finished surface shall be constructed with a tolerance of 20 mm above or below the specified levels at any point.

### **Sub base Course:**

A subgrade/sub base is made up of native soil that has been compacted to withstand the loads above it. It is a layer required in many structures such as pavements and slabs, although it needs to have certain characteristics. A subgrade might need special drainage structures to let water if it is composed of impermeable soil, and it should be graded to within plus or minus 1.5 inches of the specified elevation.

There is no consistency in regards to the terms of subbase and subgrade, but normally the subgrade is the native soil while the subbase is the layer of soil or aggregate on top of the subgrade.

### **Necessity of sub base:**

- ❖ The need for a subbase - a layer of granular material placed on a prepared subgrade - depends on the frequency of heavy truck loadings. While mandatory for major highways, a subbase is seldom required for light-duty concrete pavements.
- ❖ Performance studies and surveys have shown the conditions for which a subbase is or is not required. With this information, an engineer can analyze

these conditions and rationally decide if a subbase layer is essential.

- ❖ The function of a subbase is to help prevent pumping of fine-grained, subgrade soils. Pumping, which leads to the loss of soil material beneath slab edges and joints, occurs when three factors exist in combination: pumpable soils, excess water under the pavement, and frequent heavy truck loads.
- ❖ In the absence of heavy truck traffic, which is the case for many streets, secondary roads, and parking lots, a subbase is not needed. For these pavements, good performance can be obtained by using appropriate subgrade preparation techniques aimed at providing uniform foundation support for the pavement.

### **Purpose of stabilization**

The purpose of a stabilized base or sub-base layer is to provide a transitional load-bearing stratum between the pavement layer, which directly receives the wheel loadings of vehicular traffic, and the underlying sub-grade soil [1]. Stabilized base or sub-base materials may be used to provide support for either flexible or rigid pavements, but are more frequently used with flexible pavements. The key to strength development in stabilized base or sub-base mixtures is in the matrix that binds the aggregate particles together. The strength of the matrix is affected by the cementations material used in the mixture [2]. The amount of cementations material in a stabilized base or sub- base mix usually ranges from 5 to 10 percent by weight of the mix. The main concentration of the research is to determine various sand grain analyses and which of them is perfect for stabilization with cement to use instead of bricks or stone chips. This research also indicates the stability of the road with perfect sand cement mixing proportions.

### **MATERIALS**

The components of a stabilized base or subbase mixture include aggregate, cementitious materials, and water.

### **Aggregates**

Aggregates comprise the major portion of stabilized base. Normally, between 80 to 95 percent by weight of a stabilized base or subbase mix may consist of aggregates. A wide range of different types and gradations of aggregates have been used in stabilized base and subbase mixtures. These include conventional aggregate sources, such as crushed stone or sand and gravel, and other aggregate materials, such as blast furnace slag, recycled paving materials, and bottom ash or boiler slag from coal-fired power plants. Reclaimed pavement materials have also been successfully recycled into stabilized base and subbase mixtures, as have some marginal aggregates. Aggregates used should have the proper particle size, shape, gradation, and particle strength to contribute to a mechanically stable mixture.



## Cementitious Materials

The key to strength development in stabilized base or subbase mixtures is in the matrix that binds the aggregate particles together. The strength of the matrix is affected by the cementitious material used in the mixture. The amount of cementitious material in a stabilized base or subbase mix usually ranges from 5 to 10 percent by weight of the mix, but may in some cases comprise as much as up to 20 percent by weight if a lighter weight aggregate is used.

A number of different cementitious materials have been successfully used to bind or solidify the aggregate particles in stabilized base or subbase mixtures. The material that has been most frequently used is Portland cement.

In some parts of the United States, mainly west of the Mississippi River, fly ash from the burning of sub-bituminous coal is widely available and, because it exhibits self-cementing characteristics when mixed with water, it can be used by itself with no other cementitious material to bind aggregate particles together.

Coal fly ash, produced during the combustion of bituminous coal, is frequently used in stabilized base mixtures. Since this type of fly ash is a pozzolan, the mixtures in which it is used are often referred to as pozzolanic stabilized base (PSB) mixtures. Pozzolans are materials composed of amorphous siliceous or siliceous and aluminous material in a finely divided (powdery) form (similar in size to Portland cement particles) that will, in the presence of water, react with an activator to form compounds possessing cementitious properties. Pozzolan activators are alkaline materials that contain calcium and magnesium compounds present in sufficient amounts to chemically react in the presence of water with the silicate and aluminates in the pozzolan. Descriptions of various kinds of pozzolans and their specifications are provided in ASTM C618.

In PSB compositions, the fly ash is usually used in combination with either lime, Portland cement, or kiln dust, plus water, to form the matrix that cements the aggregate particles together. When used with a chemical reagent, this type of fly ash normally comprises between 10 and 20 percent by weight of a stabilized base or subbase mix. When used with lighter weight aggregates (such as coal bottom ash), the percentage of fly ash may be as high as 30 percent or more.

### **Types of stabilization:**

#### **Mechanical**

#### **Stabilization:**

- ❖ In this technique mechanical energy is used (rollers, plate compactors, tampers etc. By choice or nature of soil) to improve the soil properties by compaction.
- ❖ Preferably for construction of embankment for roads, railways etc.

- ❖ Mechanical stability depends upon the degree of compaction. Normally, the compaction is done at optimum water content.

### Uses—

- Simplest method of soil stabilization.
- To improve the sub-grades of low bearing capacity.
- Extensively used for construction of bases, sub-bases and surfacing of roads.

### Factors Affecting the Mechanical Stabilization

The mechanical stability of the mixed soil depends upon the following factors.

1. **Mechanical Strength of the Aggregate**— The mixed soil is stable if the aggregates used have high strength. However, if the mixture is properly designed and compacted, even the aggregates of relatively low strength can provide good mechanical stability.
2. **Mineral Composition**— the mechanical stability of the mixed soil depends upon the composition of the minerals. The minerals should be weather resistant.
3. **Gradation**— the gradation of the mixed soil should be such that the voids of the coarser particles are filled with finer particles to obtain a high density.

### (1) Plasticity Characteristics—

- ❖ For mud roads surfacing, highly plastic soils are used as binders. They possess greater cohesion, moisture retention capacity and provide seal against downward movement of surface water.
- ❖ For base courses, the soils should have low plasticity to avoid excessive accumulation of water and the resulting loss of strength.
- ❖ The soil available at site may seldom meet both the requirements. It is necessary to mix soils from different sources to obtain desired mix.

### Lime stabilization

There are basically five types of lime:

- ❖ High Calcium, quick lime (CaO)
- ❖ Hydrated, high calcium lime [Ca(OH)<sub>2</sub>]
- ❖ Dolomite lime (CaO+MgO)
- ❖ Normal, hydrated dolomitic lime [Ca(OH)<sub>2</sub>+MgO]
- ❖ Pressure, hydrated dolomitic lime [Ca(OH)<sub>2</sub>+Mg(OH)<sub>2</sub>]

- The quick lime is more effective than the hydrated lime, but the latter is more safe and convenient to handle. Generally, hydrated-lime is used. It is also known as slaked lime.
- The higher the magnesium content of the lime, the less is the affinity for water and the less is the heat generated during mixing.
- The amount of lime required varies between 2 to 10% of the soil.

Lime stabilization is done by adding lime to soil. It is useful for the stabilization of clayey soil.

- When lime reacts with soil there is exchange of cations in the absorbed water layer and a decrease in the plasticity of the soil occurs.
- The resulting material is more friable than the original clay, and is, therefore more suitable as sub-grade.

The following amount may be used as a rough guide:

- ❖ 2 to 5% for clay gravel material having less than 50% of silt-clay fraction
- ❖ 5 to 10% for soils with more than 50% of silt clay fraction
- ❖ About 10% for heavy clays used as bases and sub-bases
- ❖ For soils having particle size intermediate between (1) and (2) above, the quantity of lime required is between 3 to 7%.

Lime stabilization is not effective for sandy soils.

**Construction Method**— Construction methods used in lime stabilization are similar to those used in cement stabilization. However, the following points should be carefully noted.

- ❖ The reaction in the case of lime is slow, there is no maximum time limit between the addition of lime to the soil and the completion of compaction.
- ❖ Lime may be added in the form of slurry instead of dry powder.
- ❖ A rest period of 1 to 4 days is generally required after spreading lime over a heavy clay before final mixing is done.
- ❖ The soil-lime is compacted to the required maximum dry density.
- ❖ After compaction, the surface is kept moist for 7 days and then covered with a suitable wearing coat.

### **Cement stabilization**

- ❖ Most commonly used for road construction.
- ❖ Heavy clays are difficult to pulverize and not suitable.
- ❖ Well graded sand and gravel mixtures with upto 10% fine binder Material (passing #200 sieve).
- ❖ Quantity of cement to be determined on trial basis in lab. (minimum strength required 3.5N/mm<sup>2</sup>—7 days cube strength).
- ❖ Compaction to be completed within two hours after laying mixing with water.

**A. Central plant method:** faster construction, expansive, dry mix and then wet thoroughly, spreading and compaction.

**B. Mix in place method:** similar to agriculture rotary cultivator, firstly soil is pulverized then dry cement is spread over, then water sprinkled in layers, again remixed and shaped to camber, compacted using rollers.

#### **(1) Normal Soil-Cement—**

- ❖ It consists of 5 to 14% of cement by volume.
- ❖ Cement is sufficient to produce a hard and durable material.
- ❖ Sufficient water be used for hydration requirement & workability
- ❖ It is weather resistant and strong and used for stabilizing sandy and other low plasticity soils.

#### **(2) Plastic Soil-Cement—**

- ❖ It consists of 5 to 14% of cement by volume,
- ❖ It has more water to have wet consistency similar to that of plastering mortar at the time of placement.
- ❖ Used for water proof lining of canals and reservoirs
- ❖ Used for protection of steep slopes against water erosion.

☐

### **Fly ash stabilization**

Fly ash is a byproduct from burning coal which makes steam to generate

electricity. When burning coal, combustion particles rise out of the combustion

chamber with flue gasses. They are captured in filters to prevent them from reaching the atmosphere and collected for disposal or beneficial reuse. These particles are called fly ash.

There are two types of fly ash, Class C and Class F. Class C has self-cementing properties and is used in the production of concrete as a substitute for Portland Cement, and as a chemical stabilizing & modifying agent to dry and/or strengthen poor soils. Class F has very little self-cementing properties, but can be combined with additives such as quicklime, hydrated lime, or cement (portland or hydraulic) to create cementitious compounds for the same purposes.

### **Fly Ash in Modification, Stabilization and FDR**

**Soil Modification:** Given its cementitious properties, fly ash can dry down wet soils and increase the strength of each fill layer. It works best in sandy/silty soils, but can be very effective in lean clays as well.



**Soil & Base Stabilization:** Using fly ash to strengthen the top 8"-14" of subgrade can decrease the thickness of aggregate base and/or pavement (asphalt or concrete) needed to achieve the structural design strength of the overall pavement section. Again, it works best in sandy, silty soils, but is also a great option to stabilize existing aggregate base when performing parking lot repairs or upgrades.

**Full Depth Reclamation:** Depending on the existing make-up of the current pavement & aggregate base, fly ash can be used by itself, or in combination with other additives, to rehabilitate entire pavement sections in place.



## **Base Course:**

### **Preparation of base course**

It is the layer immediately under the wearing surface (Applies whether the wearing surface is bituminous or cement concrete and or more inch thick or is but a thin bituminous layer). As base course lies close under the pavement surface it is subjected to severe loading. The material in a base course must be of extremely high quality and its construction must be done carefully.

### **Types of Base Course**

#### 1. Granular Base Course

Fly ash yields less strength gain than Portland Cement. Typically, you need to use twice as much product to achieve similar results when compared to cement. However, if a fly ash source is within proximity of a project, utilizing it could be a better value and is worth comparing.

#### 2. Macadam Base

#### 3. In-water bound Macadam

#### 4. Treated Bases

### **Brick soling**

Soling in the construction field is the bottom-most layer of any component of the structure. It may be under floor or road. Soling may consist of bricks, stone cutting or such other building material having good crushing strength. It is one of the most common techniques used for soil stabilization.

### **Water Bound Macadam**

The concept of water bound macadam road was suggested by John Macadam, who was a Scottish engineer. The road whose wearing course consists of clean crushed aggregates, mechanically interlocked by rolling and bound together with filler material and water laid on a well compacted base course, is called water bound macadam (W.B.M) road.

This is constructed as village road serves as a base for bituminous roads. In most of the roads projects, in the first phase, W.B.M roads are constructed and when the funds are available, the surfacing is done with the premix carpet bituminous

macadam or cement concrete. So a water-bound macadam road is considered as the mother of all types of road construction.

### **Wet-mix Macadam**

Aggregates used are of the smaller sizes, varies between the 4.75 mm to 20 mm sizes and the binders (stone dust or quarry dust having PI (Plasticity Index) not less than 6%) are premixed in a batching plant or in a mixing machine. Then they are brought to the site for overlaying and compaction.

The PI (plasticity Index) of the binding material is kept low because it should be a sound and non plastic material. If the plasticity index is more then there are the chances of the swelling and more water retention properties. So this value should be kept in mind.

**Comparison of the WBM and WMM road construction:** Although the cost of construction of the WMM is said to be more than that of the WBM sub-base and bases but the advantages given below will compensate for that. Here are the points of difference:

1. The WMM roads are said to be more durable.
2. The WMM roads gets dry sooner and can be opened for traffic withing less time as compare to the WBM roads which take about one month for getting dry.
3. WMM roads are soon ready to be black topped with the Bituminous layers.
4. WMM roads are constructed at the faster rate.
5. The consumption of the water is less in case of the WMM roads.
6. Stone aggregates used in WBM is larger in size which varies from 90 mm to 20 mm depending upon the grade but in case of the WMM size varies from 4.75 mm to 20 mm.
7. In case of WBM, stone aggregates, screenings and binders are laid one after another in layers while in WMM, aggregates and binders are premixed in the batching plants and then brought to the site for overlaying and compacting.
8. Materials used in the WBM are the stone aggregates, screenings and binder material (Stone dust with water) while in WMM material used are only stone aggregates and binders.
9. Quantity of the WBM is generally measured in cubic meters while that of the WMM in square meters.

### **Surfacing:**

#### **□ Surface dressing**

- ❖ A Surface Dressing is a process of spraying a road surface with bituminous binder and then covering the binder with clean, crushed aggregate or natural gravel.
- ❖ These layers are then rolled in order to press the aggregate into the binder film.
- ❖ Traffic movement commences the process of chipping movement which will



produce eventually an interlocking matrix.

The main objective of adopting surface dressing as a wearing coat over bituminous macadam is to achieve water proofed, anti skid but comparatively less expensive wearing coat which can last for more duration as compare to other wearing surfaces.

### **(i) Premix carpet**

Premix carpet (PC) is the oldest hot mix in India. It is a good, economical, bituminous wearing course mix to be placed directly on water bound macadam (WBM) of low-volume rural roads. The premix carpet is also provided with a bituminous sand seal coat to minimize direct penetration of rainwater into it.

### **(ii) Semi dense carpet**

The semi-dense bituminous concrete mixes have neither dense or open graded characteristics. It consists of the so called pessimum voids when they are fully constructed. This will create the separation of aggregate and the bitumen in the BM layer.

### **Bituminous concrete(BC)**

- BC is a dense graded bituminous mix used as wearing course for heavily trafficked roads.
- BC mix consists of coarse aggregates, fine aggregates, filler and binder blended as per marshall mix design.

### **Quality control operations involved are:**

- Design of mix in laboratory, and control of mixing, laying and rolling temperatures
- Density, Marshall Stability, Flow, Air Voids, Retained Stability, Bitumen Content, Gradation of aggregates are controlled
- Riding quality is a control

### **Grouting**

Grouting is generally a mixture of cement, sand and water. Different type of grouting are used for different purposes but generally They are used in the purpose of repairing of concrete cracks, filling seams and gaps in tiles, seal and fill gaps for waterproofing courses, and for soil stabilization in boring well and foundation. It is also used to give extra strength to the foundations of load-bearing structures.

Grouting in civil engineering refers to the injection of pumpable materials into a soil or rock formation to change its physical characteristics. It is one of the ways ground water can be controlled during civil engineering works.

Grouting is suitable where soil permeability would create a heavy demand on pumping or where ground conditions mean it may be economically inefficient to bore wells. Grout may also be used in the formation of pile foundations, ground anchors, under-reaming, underpinning, in road construction, dam construction, and other applications.

Different materials may be used for grouting depending upon factors such as the soil or rock type and the area to be grouted. However, the basic process is the same:

the soil or rock is injected with fluid grout which sets and reduces or acts as a sealant on the material's permeability.

Grouting is relatively costly and so wastage must be controlled. This is achieved by the use of additives which improve the gelling properties of the grout and limit its spread through the ground.

## **UNIT 5-HILL ROADS**

### **Introduction:**

- Roads constructed in mountains region is called hill roads.
- There are different considerations while designing hill roads as compare to plain area roads.
- Types of curve used in hill roads is of different than plain road.
- All geometric parameters will gets changes while designing hill roads such as- Curves, Super elevation, SSD, OSD, Extra Widening, etc.

### **Components parts of Hill Roads**

1. Road Bed
2. Side Drain
3. Parapet Drain
4. Catch Water Drains
5. Brest Wall
6. Retaining Wall
7. Cross Drains

### **Road Bed**

- The pavement potion of hill road is called road bed.
- **Function:** To resist stresses developed due to moving traffic.

### **Side Drain**

- Drain provided on the sides of road is called side drain.
- Side drains runs parallel to the length of road.
- **Function:** To collect and drain off rain water collected from camber of road.

### **Parapet Wall**

- Wall which is provided above the formation level in the down side slopeis called parapet well.
- **Function:** Protection to the traffic against falling down the hill slope.

### **Catch Water drain**

- It is drain provided on higher slope running parallel to the length of road.
- **Function:** To make intercept for runoff coming from top of hill and divert water in to nearby cross drains.

### **Brest Wall**

- The wall constructed to upside slope is called retaining wall.
- **Function:** Protect road from sliding of upside slope.